

# SOFAS & CORNER SOFAS

**SitForm.**  
redefine your space



## G.60 SOFA

---

### TECHNICAL SPECIFICATIONS

---

INTERIOR STRUCTURE BEECH HARDWOOD FRAME AND ZIGZAG BOW

SEAT CUSHION HR FOAM

BACK HR FOAM

UPHOLSTERY TIGHT

MAINTENANCE ALL DECORATIVE CUSHIONS ARE GOOSE DOWN AND SILICON MIX, QUANTITY AND DIMENSIONS ARE AS PER TECHNICAL.

We recommend shaking and fluffing-up the cushions regularly to maintain the shape. This should be done after removing the cushions from the structure for improved air circulation. For maintenance of fabric and leather, please contact your retailer.

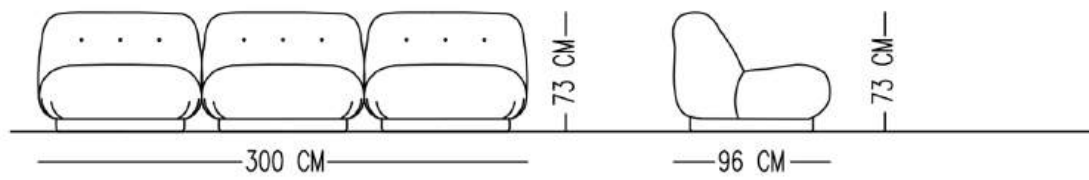

## STANDARDS

SOFA - 300 CM

SOFA - 430 CM

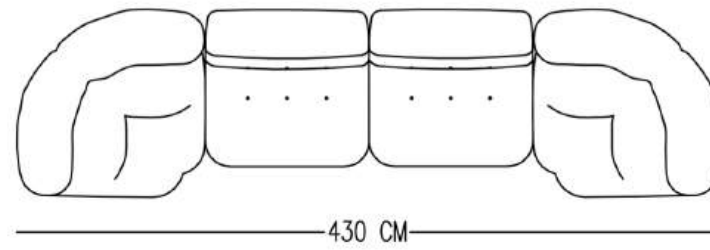
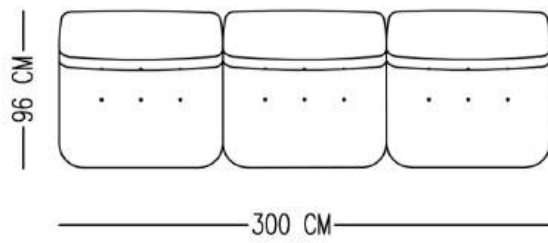

## MODULES

MODULE 01

MODULE 02 (L-R)

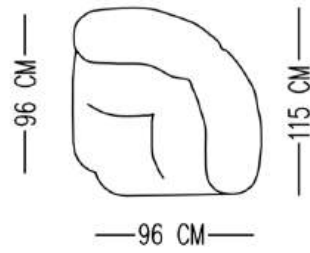
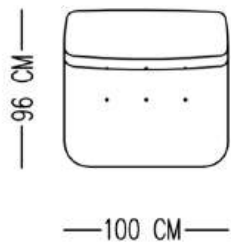

Catalog product-fabric  
Pisa 05

Catalog product-Legs  
Fabric Covering

Alternative fabric  
Pisa teddy fabric



## TOPRAK SOFA

### TECHNICAL SPECIFICATIONS

INTERIOR STRUCTURE

BEECH HARDWOOD FRAME

SEAT CUSHION

HR FOAM

ARMREST

PLEXY

UPHOLSTERY

TIGHT

MAINTENANCE

ALL DECORATIVE CUSHIONS ARE GOOSE DOWN AND SILICON MIX, QUANTITY AND DIMENSIONS ARE AS PER TECHNICAL.

We recommend shaking and fluffing-up the cushions regularly to maintain the shape. This should be done after removing the cushions from the structure for improved air circulation. For maintenance of fabric and leather, please contact your retailer.



## STANDARDS

SOFA - 220 CM

SOFA - 240 CM

SOFA - 260 CM

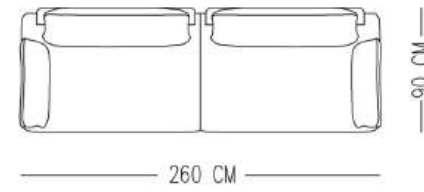
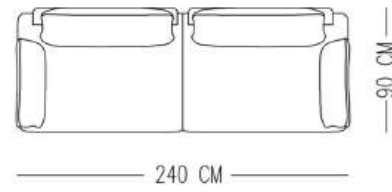
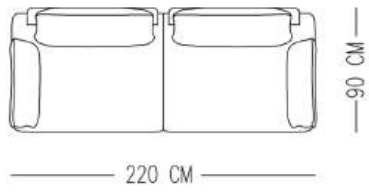

## MODULES

MODULE 01 (L-R)

MODULE 02 (L-R)

MODULE 03 (L-R)

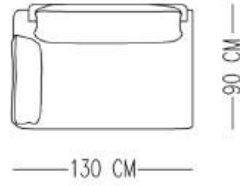
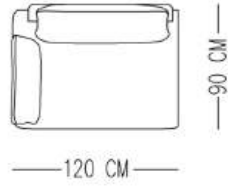
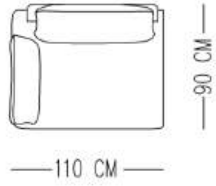

Catalog product-fabric  
Omerta-4282

Catalog product-Arm  
Bronze plexy

Alternative fabric  
Linen, Linen teddy, Suede, Leather and  
Boucle



## NIORA SOFA

---

### TECHNICAL SPECIFICATIONS

---

INTERIOR STRUCTURE

BEECH PLYWOOD FRAME

SEAT CUSHION

HR FOAM

BACK

HR FOAM

UPHOLSTERY

TIGHT

MAINTENANCE

ALL DECORATIVE CUSHIONS ARE GOOSE DOWN AND SILICON MIX, QUANTITY AND DIMENSIONS ARE AS PER TECHNICAL.

We recommend shaking and fluffing-up the cushions regularly to maintain the shape. This should be done after removing the cushions from the structure for improved air circulation. For maintenance of fabric and leather, please contact your retailer.

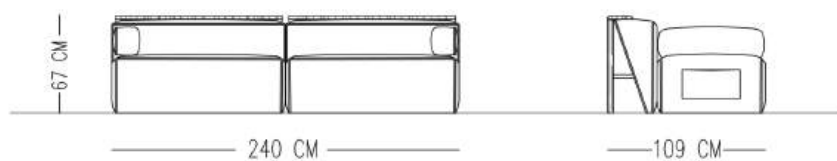

## STANDARDS

SOFA - 240 CM

SOFA - 260 CM

SOFA - 280 CM

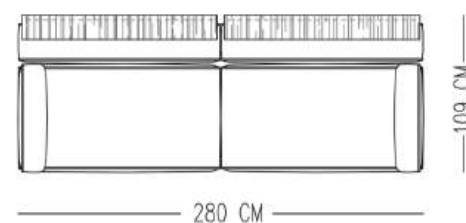
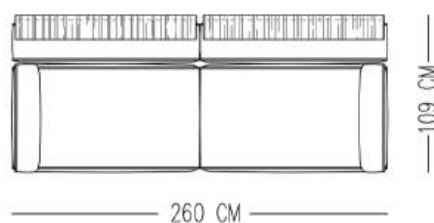
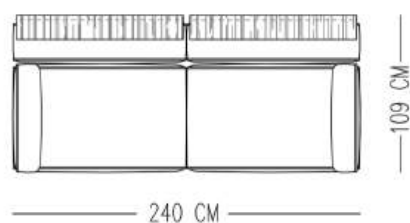

## MODULES

MODULE 01 (L-R)

MODULE 02 (L-R)

MODULE 03 (L-R)

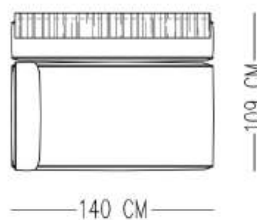
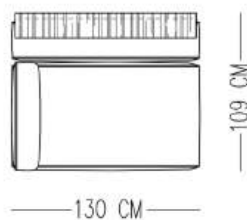
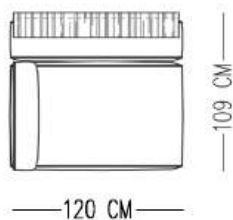

Catalog product-fabric  
Kinali-7

Back fabric  
N-02HP paint finish on  
oak wood Veneering (Matt)

Alternative fabric  
Linen, Linen teddy, Suede, Leather and  
Boucle



## LYDIA SOFA

### TECHNICAL SPECIFICATIONS

#### INTERIOR STRUCTURE

BEECH HARDWOOD FRAME AND WOODEN BASE

#### SEAT CUSHION

HR FOAM

#### BACK

HR FOAM

#### UPHOLSTERY

TIGHT

#### MAINTENANCE

ALL DECORATIVE CUSHIONS ARE GOOSE DOWN AND SILICON MIX, QUANTITY AND DIMENSIONS ARE AS PER TECHNICAL.

We recommend shaking and fluffing-up the cushions regularly to maintain the shape. This should be done after removing the cushions from the structure for improved air circulation. For maintenance of fabric and leather, please contact your retailer.

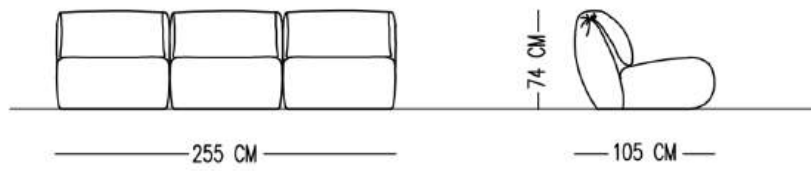

## STANDARDS

SOFA - 255 CM

SOFA - 361 CM

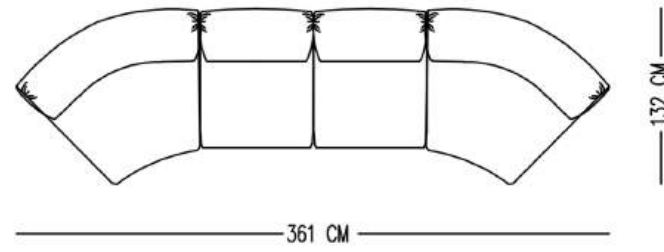
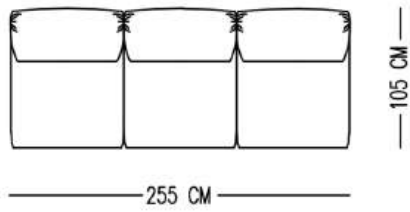

## MODULES

MODULE 01

MODULE 02 (L-R)

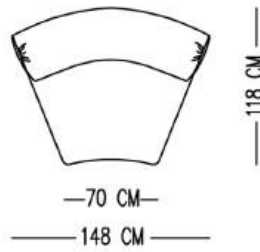
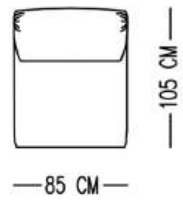

Catalog product-fabric  
Enjoy me-14

Alternative fabric  
Linen, Linen teddy, Suede, Leather and  
Boucle



## MATH SOFA

---

### TECHNICAL SPECIFICATIONS

---

#### INTERIOR STRUCTURE

BEECH HARDWOOD FRAME AND WOODEN BASE

#### SEAT CUSHION

HR FOAM

#### BACK

HR FOAM

#### UPHOLSTERY

TIGHT

#### MAINTENANCE

ALL DECORATIVE CUSHIONS ARE GOOSE DOWN AND SILICON MIX, QUANTITY AND DIMENSIONS ARE AS PER TECHNICAL

We recommend shaking and fluffing-up the cushions regularly to maintain the shape. This should be done after removing the cushions from the structure for improved air circulation. For maintenance of fabric and leather, please contact your retailer.

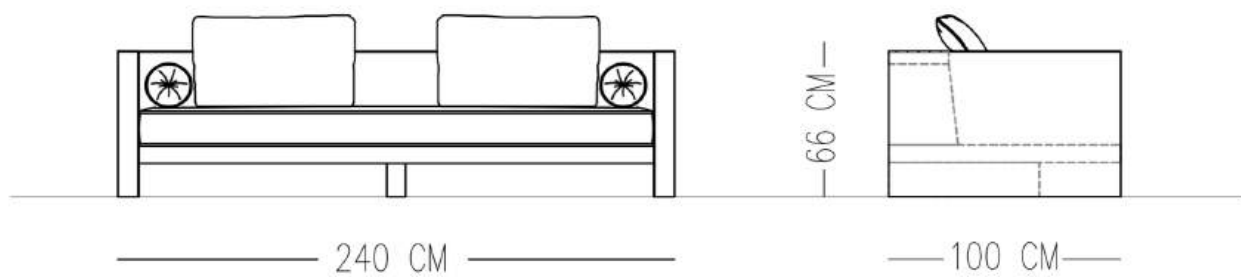

## STANDARDS

---

SOFA - 240 CM

---

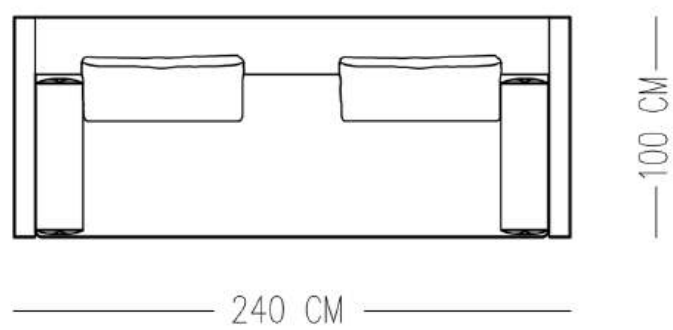

Catalog product-fabric

Vernon stonewash-1

Catalog product- Back

Lacquer painted on wood  
(Matt) N-03K19

Alternative fabric

Linen, Linen teddy, Suede, Leather and  
Boucle



## SIXPACK SOFA

### TECHNICAL SPECIFICATIONS

INTERIOR STRUCTURE

BEECH HARDWOOD FRAME AND ZIGZAG BOW

SEAT CUSHION

HR FOAM

BACK

HR FOAM

UPHOLSTERY

TIGHT

MAINTENANCE

ALL DECORATIVE CUSHIONS ARE GOOSE DOWN AND SILICON MIX, QUANTITY AND DIMENSIONS ARE AS PER TECHNICAL

We recommend shaking and fluffing-up the cushions regularly to maintain the shape. This should be done after removing the cushions from the structure for improved air circulation. For maintenance of fabric and leather, please contact your retailer.

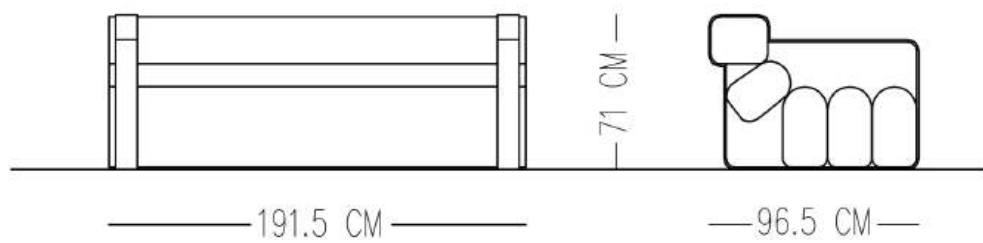

## STANDARDS

---

SOFA - 191.5 CM

---

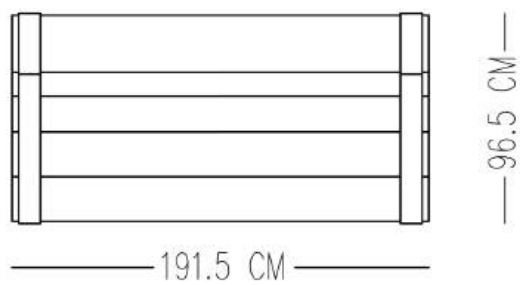

Catalog product-fabric

Barano-304

Catalog product-arm

Oak veneering with bitter  
brown varnish

Alternative fabric

Linen, Linen teddy, Suede, Leather and  
Boucle



## ME SOFA

---

### TECHNICAL SPECIFICATIONS

---

INTERIOR STRUCTURE BEECH HARDWOOD FRAME AND ZIGZAG BOW

SEAT CUSHION HR FOAM

BACK HR FOAM

UPHOLSTERY TIGHT

MAINTENANCE ALL DECORATIVE CUSHIONS ARE GOOSE DOWN AND SILICON MIX, QUANTITY AND DIMENSIONS ARE AS PER TECHNICAL.

We recommend shaking and fluffing-up the cushions regularly to maintain the shape. This should be done after removing the cushions from the structure for improved air circulation. For maintenance of fabric and leather, please contact your retailer.

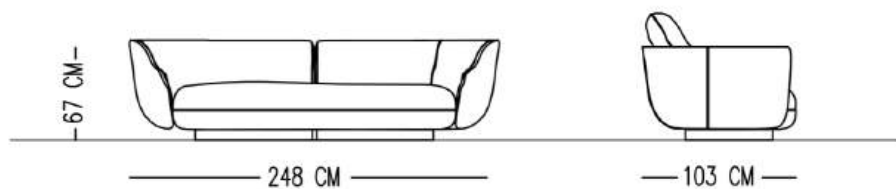

## STANDARDS

SOFA - 248 CM

SOFA - 280 CM

SOFA - 320 CM

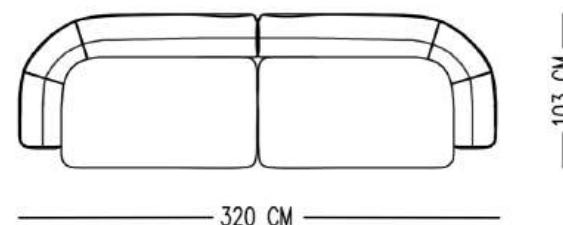
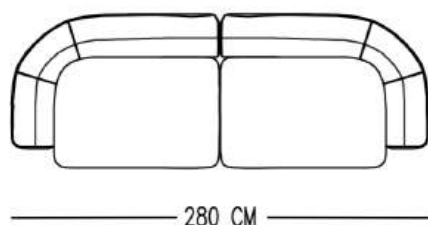
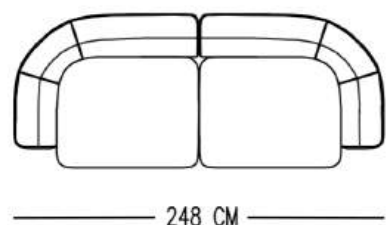

## MODULES

MODULE 01 (L-R)

MODULE 02 (L-R)

MODULE 03 (L-R)

CUSHION

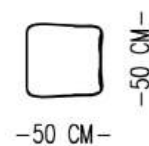
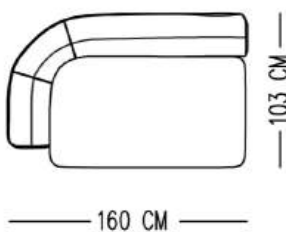
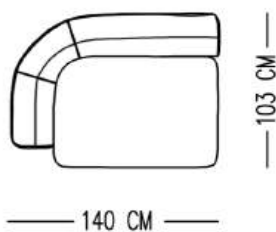
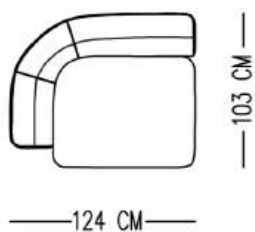

Catalog product-fabric

N-+A50/Linen  
14510

Back fabric

N-+A72/Leather  
Khaki

Catalog product-Legs

Laquer Painted On Wood (Matt)  
N-03K19

Alternative fabric

Linen, Linen teddy, Suede, Leather and  
Boucle



## OLIVS SOFA

### TECHNICAL SPECIFICATIONS

INTERIOR STRUCTURE BEECH HARDWOOD FRAME AND ZIGZAG BOW

SEAT CUSHION HR FOAM

BACK HR FOAM

UPHOLSTERY TIGHT

MAINTENANCE ALL DECORATIVE CUSHIONS ARE GOOSE DOWN AND SILICON MIX, QUANTITY AND DIMENSIONS ARE AS PER TECHNICAL DRAWINGS. STANDART WITH 4 CUSHIONS

We recommend shaking and fluffing-up the cushions regularly to maintain the shape. This should be done after removing the cushions from the structure for improved air circulation. For maintenance of fabric and leather, please contact your retailer.

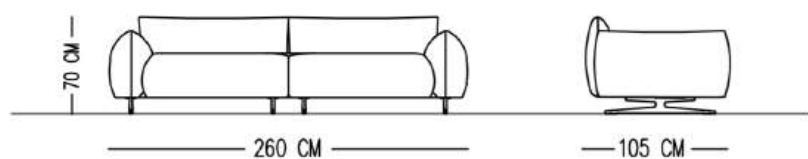

## STANDARDS

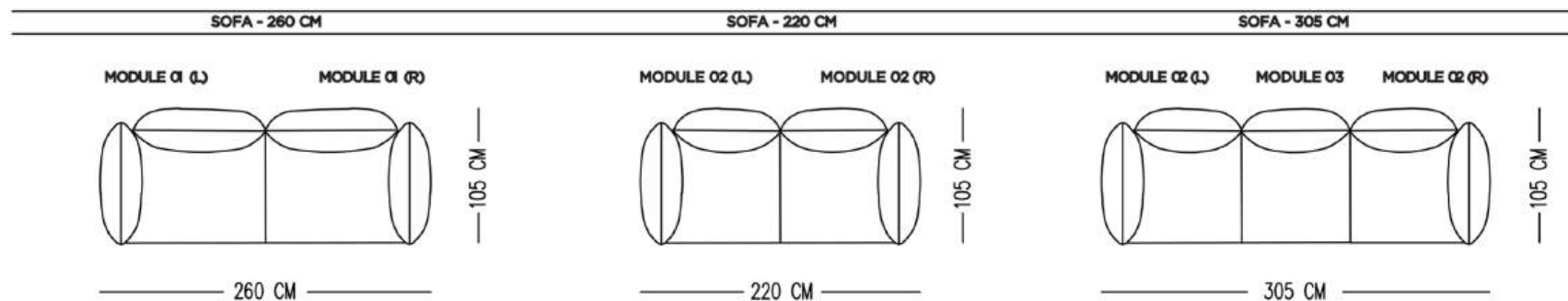

## MODULES

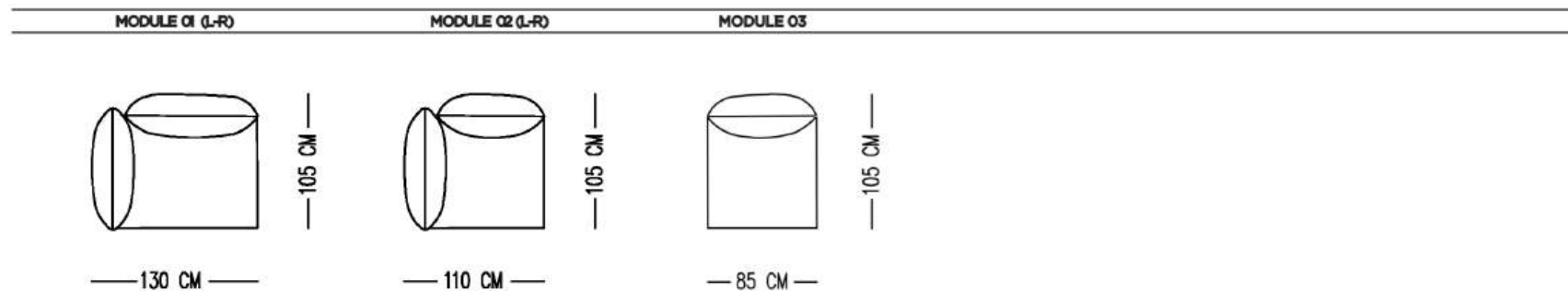

Catalog product-fabric  
N-A10/Linen  
40443

Catalog product-Legs  
Hidden leg

Alternative fabric  
Linen and Boucle



---

## ROSA SOFA

---

INTERIOR STRUCTURE    BEECH HARDWOOD FRAME AND ZIGZAG BOW

SEAT CUSHION    HR FOAM

BACK    HR FOAM

UPHOLSTERY    TIGHT

MAINTENANCE    ALL DECORATIVE CUSHIONS ARE GOOSE DOWN AND SILICON MIX. QUANTITY AND DIMENSIONS ARE AS PER TECHNICAL.

We recommend shaking and fluffing-up the cushions regularly to maintain the shape. This should be done after removing the cushions from the structure for improved air circulation. For maintenance of fabric and leather, please contact your retailer.

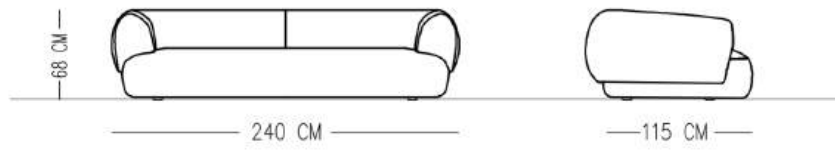

## STANDARDS

SOFA - 240 CM

SOFA - 260 CM

SOFA - 280 CM

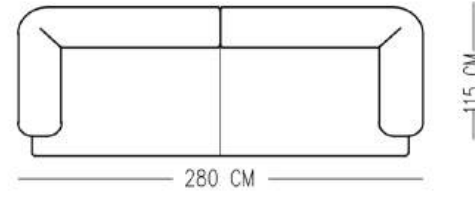
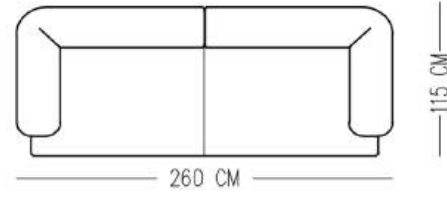
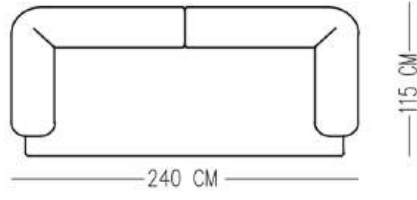

## MODULES

MODULE 01 (L-R)

MODULE 02 (L-R)

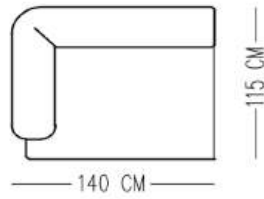
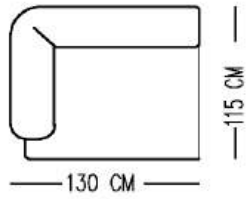

Catalog product-fabric

N-+A81/Linen  
179300

Catalog product-Legs

Hidden legs



# TOM SOFA

---

## TECHNICAL SPECIFICATIONS

---

INTERIOR STRUCTURE

METAL STRUCTURE WITH CHROMIUM POLISH

SEAT CUSHION

COWHIDE LEATHER

UPHOLSTERY

COWHIDE LEATHER

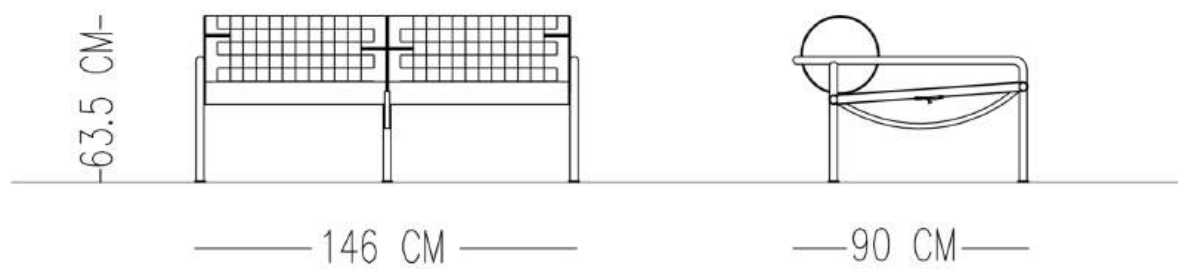

## STANDARDS

---

SOFA - 146 CM

---

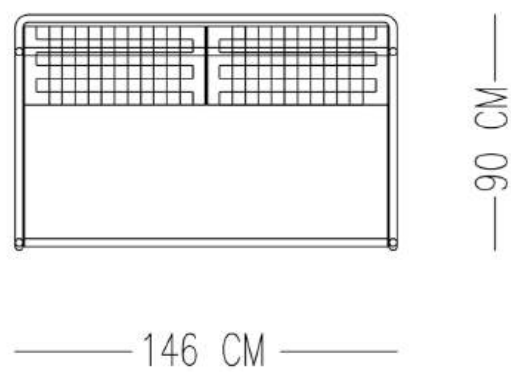

Catalog product-fabric  
N+A84/Leather  
Taba

Catalog product-Legs  
Chromium

Alternative fabric  
Fabrics only N+A84 are available for this model



---

## RIVER SOFA

---

INTERIOR STRUCTURE BEECH HARDWOOD FRAME AND ZIGZAG BOW

SEAT CUSHION HR FOAM

BACK HR FOAM

UPHOLSTERY TIGHT

MAINTENANCE ALL DECORATIVE CUSHIONS ARE GOOSE DOWN AND SILICON MIX, QUANTITY AND DIMENSIONS ARE AS PER TECHNICAL.

We recommend shaking and fluffing-up the cushions regularly to maintain the shape. This should be done after removing the cushions from the structure for improved air circulation. For maintenance of fabric and leather, please contact your retailer.

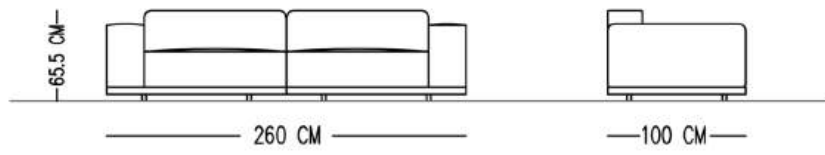

## STANDARDS

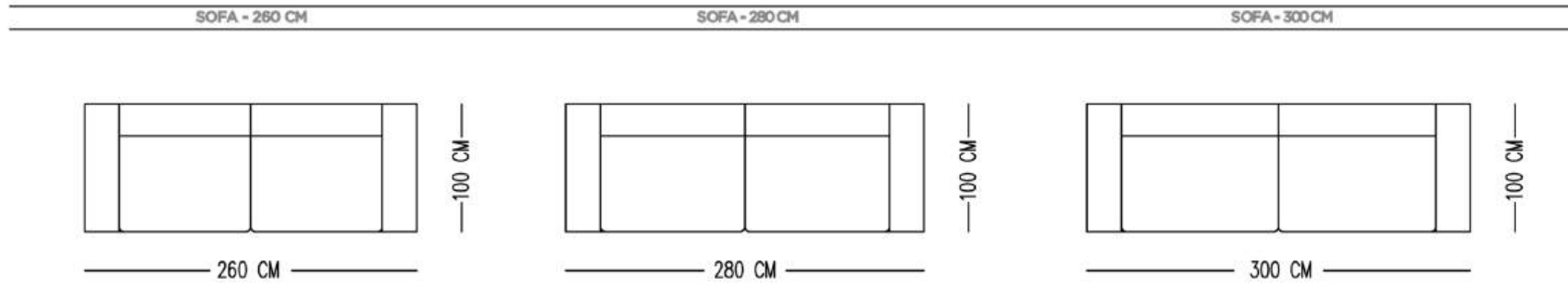

## MODULES

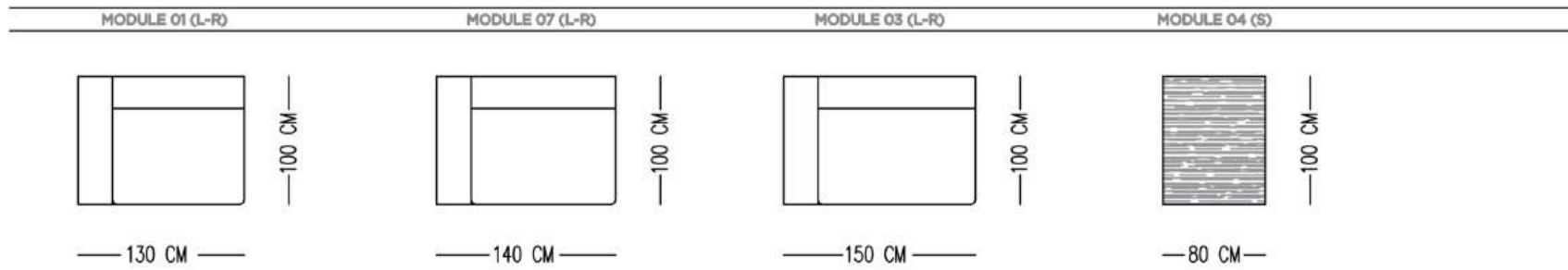

Catalog product-fabric  
N-+A81/Boucle  
179300

Coffee Table  
Oak veneering with bitter  
brown varnish

Base  
Leather

Catalog product-Legs  
Black Leg

Alternative fabric  
Linen and Boucle



## VIENTOS SOFA

### TECHNICAL SPECIFICATIONS

INTERIOR STRUCTURE BEECH HARDWOOD FRAME AND ZIGZAG BOW

SEAT CUSHION HR FOAM

BACK HR FOAM

UPHOLSTERY TIGHT

MAINTENANCE ALL DECORATIVE CUSHIONS ARE GOOSE DOWN AND SILICON MIX. QUANTITY AND DIMENSIONS ARE AS PER TECHNICAL DRAWINGS. STANDART WITH 4 CUSHIONS

We recommend shaking and fluffing-up the cushions regularly to maintain the shape. This should be done after removing the cushions from the structure for improved air circulation. For maintenance of fabric and leather, please contact your retailer.

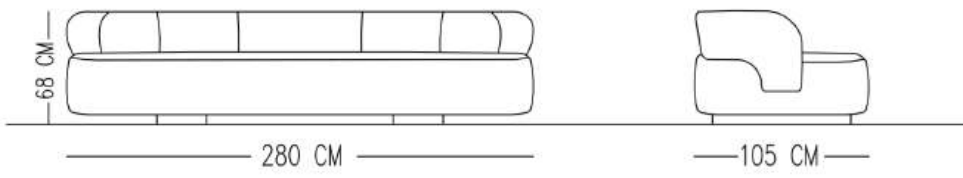

## STANDARDS

SOFA - 240 CM

SOFA - 260 CM

SOFA - 280 CM

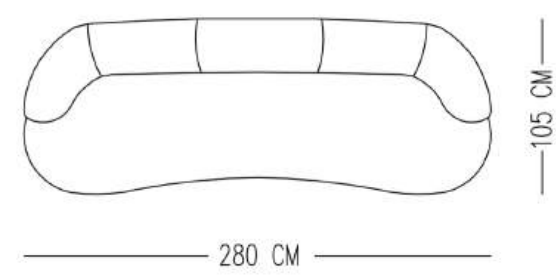
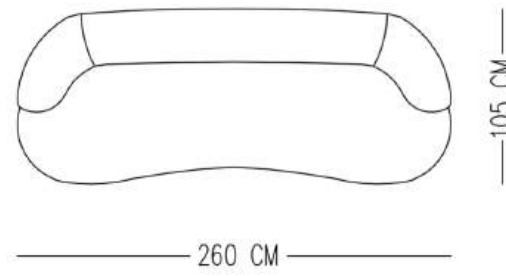
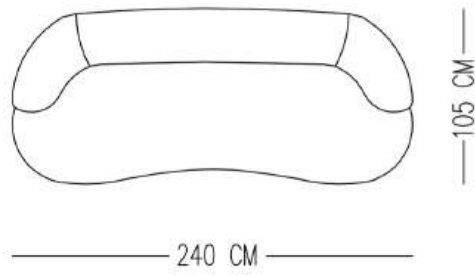

Catalog product-fabric  
N+A71/Linen boucle  
2126

Catalog product-Legs  
Hidden legs

Alternative fabric  
Linen, Boucle, Faux leather



## VIBE SOFA

---

### TECHNICAL SPECIFICATIONS

---

INTERIOR STRUCTURE    BEECH HARDWOOD FRAME AND ZIGZAG BOW

SEAT CUSHION    HR FOAM

BACK    HR FOAM

UPHOLSTERY    TIGHT

MAINTENANCE    ALL DECORATIVE CUSHIONS ARE GOOSE DOWN AND SILICON MIX, QUANTITY AND DIMENSIONS ARE AS PER TECHNICAL DRAWINGS. STANDART WITH 4 CUSHIONS

We recommend shaking and fluffing-up the cushions regularly to maintain the shape. This should be done after removing the cushions from the structure for improved air circulation. For maintenance of fabric and leather, please contact your retailer.

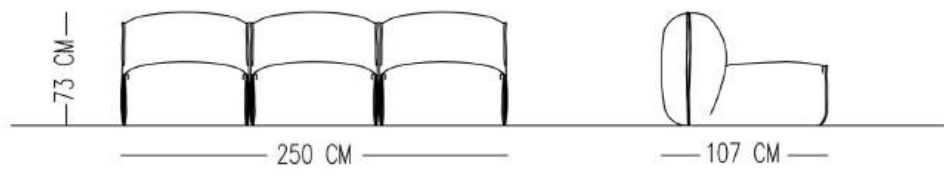

## STANDARDS

SOFA - 250 CM

SOFA - 300 CM

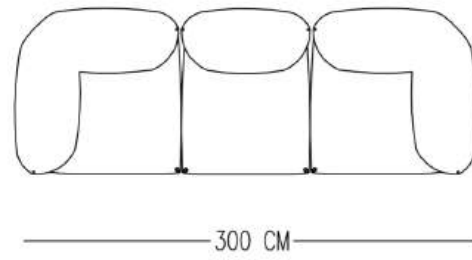
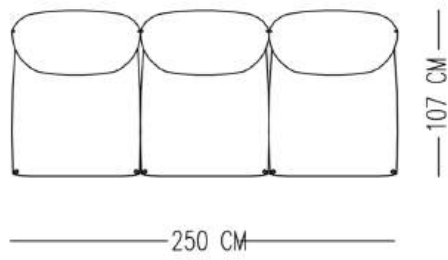

## MODULES

MODULE 01

MODULE 04 (L-R)

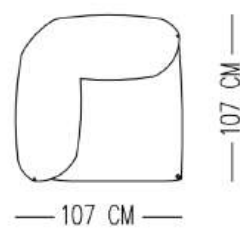
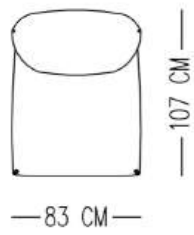

Catalog product-fabric

Catalog product-Legs

Hidden leg

N-A38/Linen  
Nata

Alternative fabric  
Linen, Boucle and Linen teddy



## DOMINO SOFA

---

### TECHNICAL SPECIFICATIONS

---

INTERIOR STRUCTURE    BEECH HARDWOOD FRAME

SEAT CUSHION    HR FOAM

BACK    HR FOAM

UPHOLSTERY    TIGHT

MAINTENANCE    ALL DECORATIVE CUSHIONS ARE GOOSE DOWN AND SILICON MIX, QUANTITY AND DIMENSIONS ARE AS PER TECHNICAL:

We recommend shaking and fluffing-up the cushions regularly to maintain the shape. This should be done after removing the cushions from the structure for improved air circulation. For maintenance of fabric and leather, please contact your retailer.

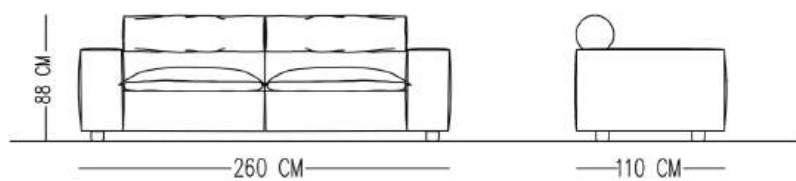

## STANDARDS

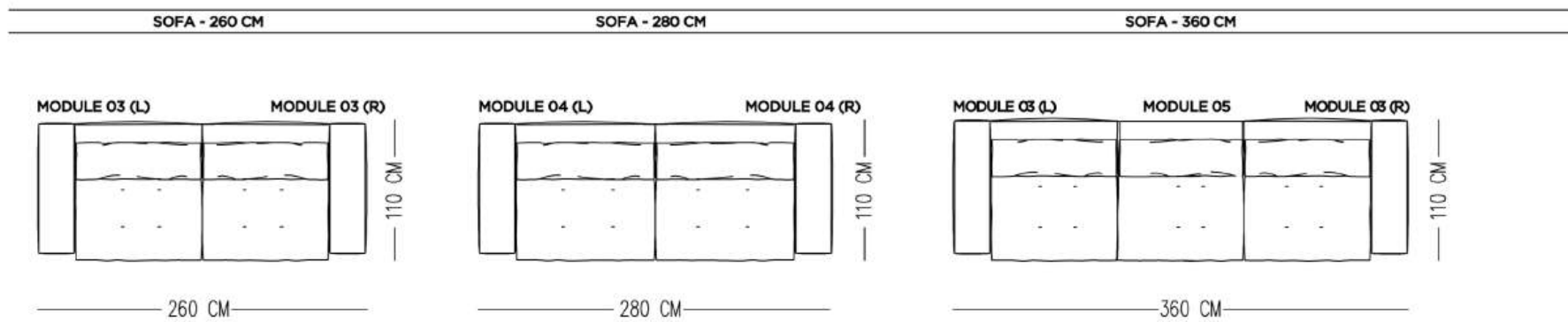

## MODULES

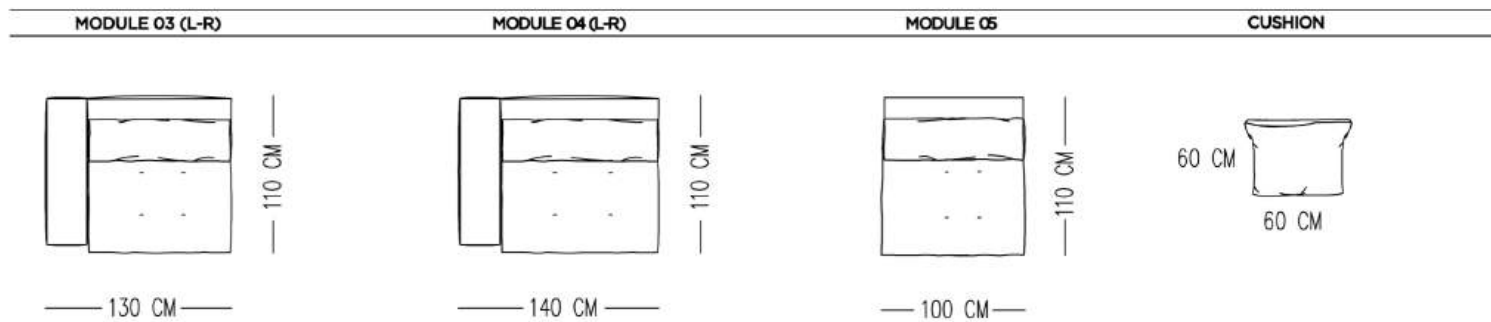

Catalog product-fabric

N-A37/Soft Velvet  
15 Frost

Catalog product-Legs

Hidden leg

Alternative fabric  
Linen,Soft velvet and Nubuck



## BULUT SOFA

### TECHNICALS PECIFICATIONS

INTERIOR STRUCTURE BEECH WOOD AND STEEL AND MDF WITH ZIGZAG BOW

STRUCTURE PADDING HR FOAM

SEAT CUSHION HR FOAM

BACK BACK CUSHION 100% DOWN/FEATHERS

UPHOLSTERY LOOSE

MAINTENANCE ALL DECORATIVE CUSHIONS ARE GOOSE DOWN AND SILICON MIX, QUANTITY AND DIMENSIONS ARE AS PER TECHNICAL DRAWINGS. STANDART WITH 2 CUSHIONS 60\*60, 2 CUSHIONS 45\*45, 1 CUSHIONS 35\*55.

We recommend shaking and fluffing-up the cushions regularly to maintain the shape.

This should be done after removing the cushions from the structure for improved air circulation.

For maintenance of fabric and leather, please contact your retailer.





## MARLON SOFA

---

### TECHNICAL SPECIFICATIONS

---

INTERIOR STRUCTURE    FRAME BEECH CONTRA, STEEL AND ZIGZAG BOW

SEAT CUSHION    HR FOAM

BACK    HR FOAM

UPHOLSTERY    TIGHT

MAINTENANCE    ALL DECORATIVE CUSHIONS ARE GOOSE DOWN AND SILICON MIX, QUANTITY AND DIMENSIONS ARE AS PER TECHNICAL DRAWINGS. STANDART WITH 2 CUSHIONS 50\*50.

We recommend shaking and fluffing-up the cushions regularly to maintain the shape. This should be done after removing the cushions from the structure for improved air circulation. For maintenance of fabric and leather, please contact your retailer.

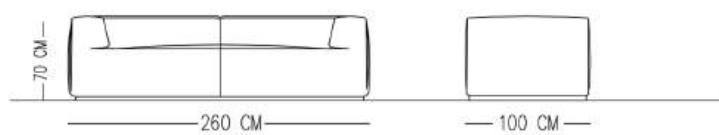

## STANDARDS

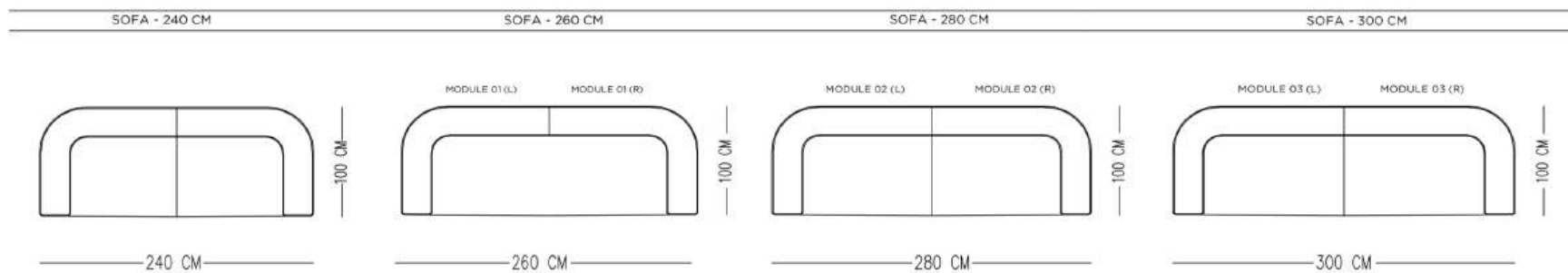

## MODULES

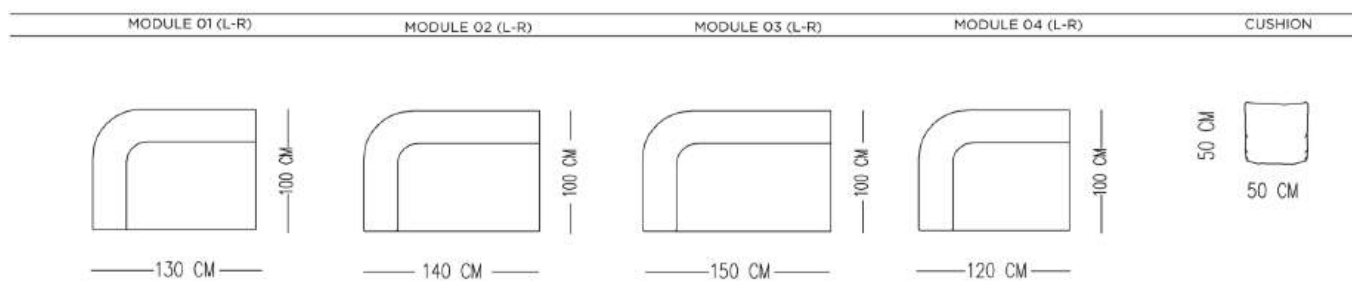

Catalog product-fabric

N-C19/Linen  
21556-03

Catalog product-Legs

Hidden Wooden base and leg

Alternative fabric  
Linen, Boucle and Nubuck



## FRAME SOFA

### TECHNICAL SPECIFICATIONS

INTERIOR STRUCTURE    FRAME BEECH CONTRA, STEEL AND ZIGZAG BOW

SEAT CUSHION    HR FOAM

BACK    HR FOAM

UPHOLSTERY    TIGHT

MAINTENANCE    ALL DECORATIVE CUSHIONS ARE GOOSE DOWN AND SILICON MIX, QUANTITY AND DIMENSIONS ARE AS PER TECHNICAL DRAWINGS. STANDART WITH 2 CUSHIONS 50\*50.

We recommend shaking and fluffing-up the cushions regularly to maintain the shape. This should be done after removing the cushions from the structure for improved air circulation. For maintenance of fabric and leather, please contact your retailer.

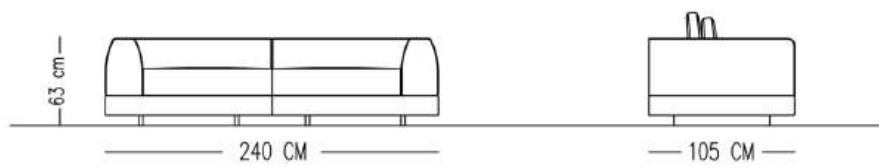

## STANDARDS

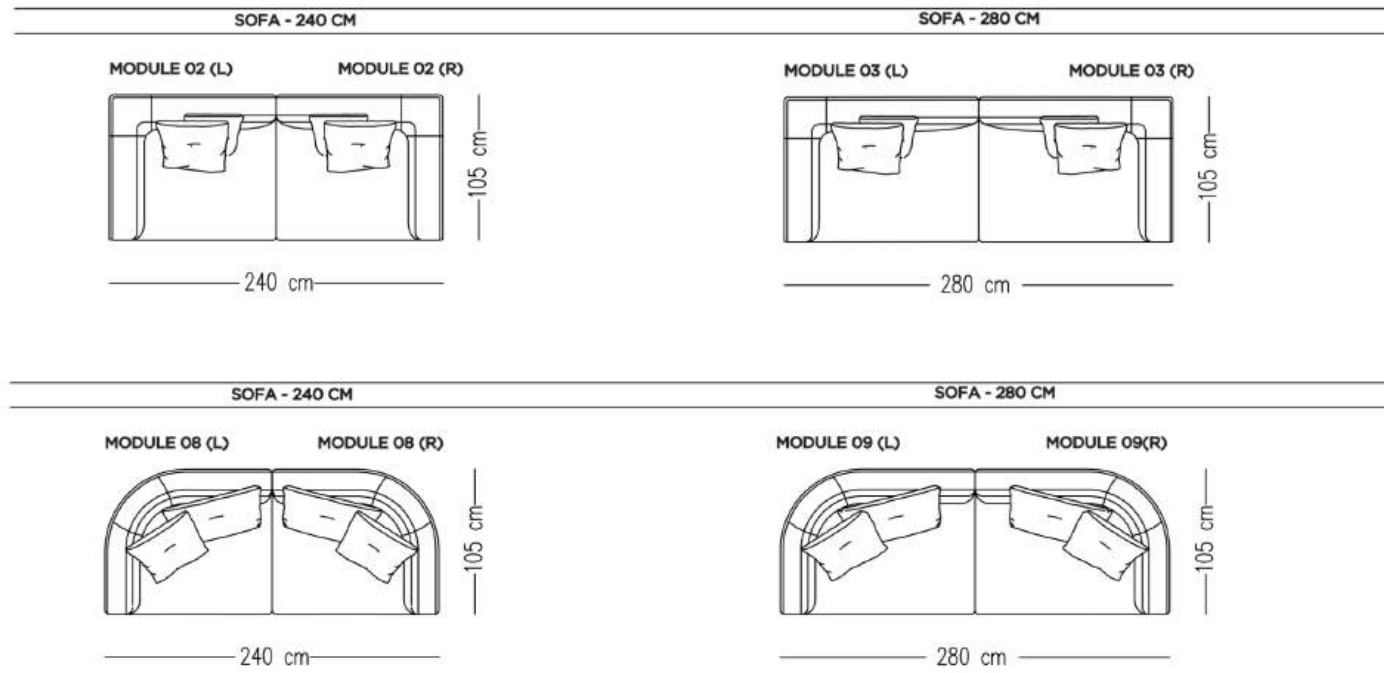

## MODULES

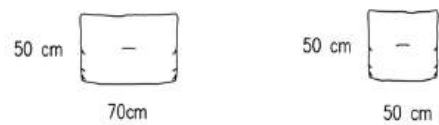
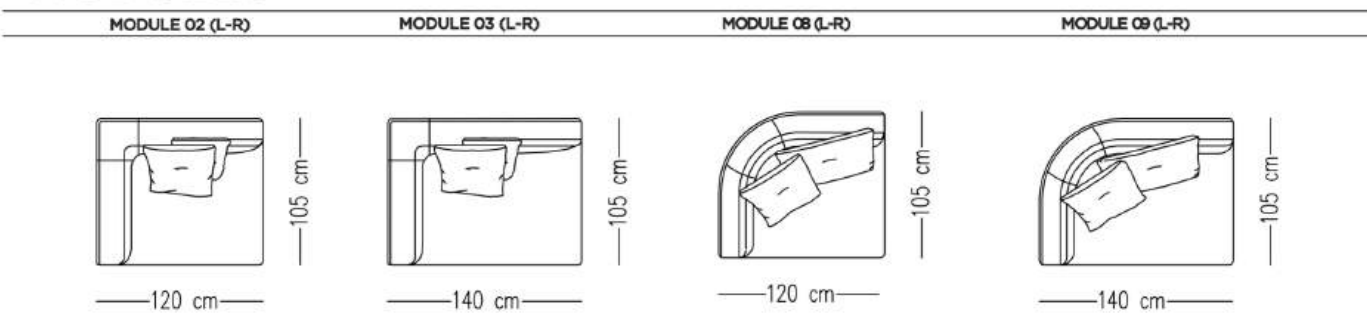

Catalog product-fabric

N-A62/Linen  
4093

Catalog product-Legs

Hidden Leg

Alternative fabric  
Linen, Boucle and Nubuck



## ITALS SOFA

### TECHNICAL SPECIFICATIONS

INTERIOR STRUCTURE BEECH HARDWOOD FRAME AND ELASTIC COLUMN

SEAT CUSHION HR FOAM

BACK HR FOAM

UPHOLSTERY TIGHT

MAINTENANCE ALL DECORATIVE CUSHIONS ARE GOOSE DOWN AND SILICON MIX, QUANTITY AND DIMENSIONS ARE AS PER TECHNICAL DRAWINGS. STANDART WITH 3 CUSHIONS 25\*55, 1 CUSHIONS 45\*45

We recommend shaking and fluffing-up the cushions regularly to maintain the shape. This should be done after removing the cushions from the structure for improved air circulation. For maintenance of fabric and leather, please contact your retailer.



## STANDARDS

SOFA - 222 CM      SOFA - 242 CM      SOFA - 262 CM

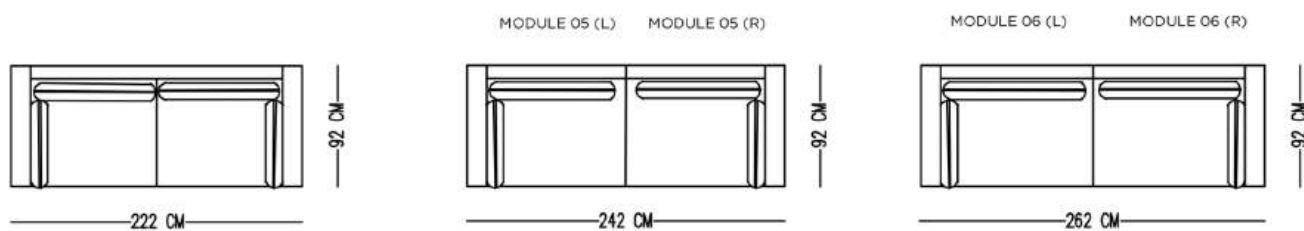

## MODULES

MODULE 05 (L-R)      MODULE 06 (L-R)      CUSHION 01      CUSHION 02

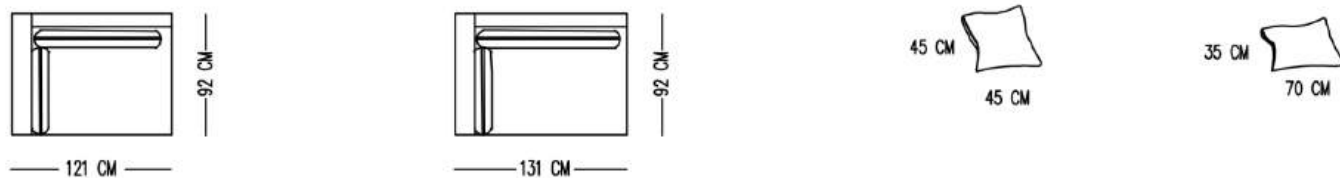

Catalog product-fabric

Tabu-0057

Catalog product-Legs

Chromium

Alternative fabric  
Linen and Boucle



## PORTO SOFA

### TECHNICAL SPECIFICATIONS

INTERIOR STRUCTURE    FRAME BEECH CONTRA AND ELASTIC COLUMN

SEAT CUSHION    HR FOAM

BACK    HR FOAM

UPHOLSTERY    TIGHT

MAINTENANCE    ALL DECORATIVE CUSHIONS ARE GOOSE DOWN AND SILICON MIX. QUANTITY AND DIMENSIONS ARE AS PER TECHNICAL DRAWINGS. STANDART WITH 4 CUSHIONS 50\*50, 5 CUSHIONS 50\*70

We recommend shaking and fluffing-up the cushions regularly to maintain the shape. This should be done after removing the cushions from the structure for improved air circulation. For maintenance of fabric and leather, please contact your retailer.

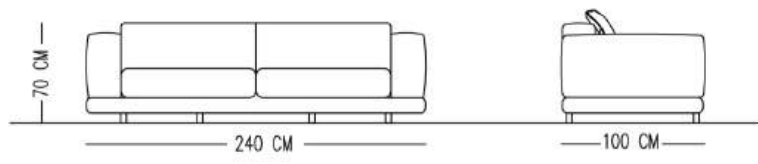

## STANDARDS

SOFA - 240 CM

SOFA - 260 CM

SOFA - 280 CM

CUSHION 01

CUSHION 02

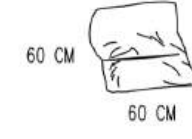
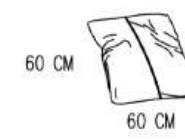
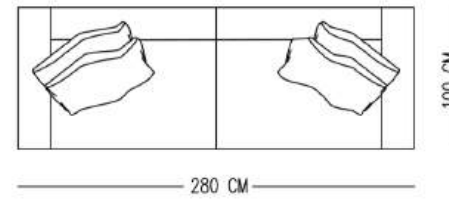
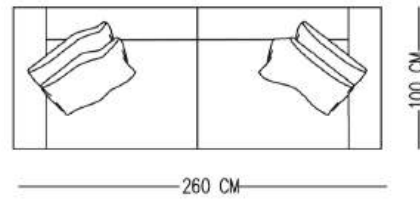
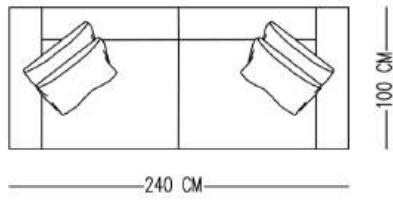

Catalog product-fabric  
N-B33/Linen  
09

Catalog product-Legs  
Wood wenge varnish

Alternative fabric  
Linen and Boucle



## ANGE SOFA

### TECHNICAL SPECIFICATIONS

INTERIOR STRUCTURE BEECH WOOD AND ELASTIC COLUMN

SEAT CUSHION HR FOAM

BACK HR FOAM

UPHOLSTERY TIGHT

MAINTENANCE ALL DECORATIVE CUSHIONS ARE GOOSE DOWN AND SILICON MIX, QUANTITY AND DIMENSIONS ARE AS PER TECHNICAL DRAWINGS. STANDART WITH 3 CUSHIONS 55\*55, 3 CUSHIONS 45\*45.

We recommend shaking and fluffing-up the cushions regularly to maintain the shape. This should be done after removing the cushions from the structure for improved air circulation. For maintenance of fabric and leather, please contact your retailer.

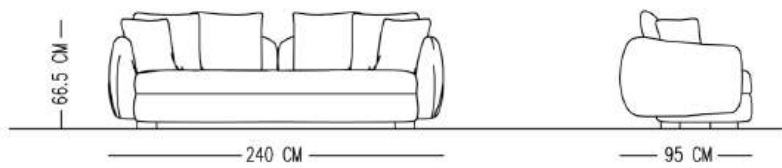

## STANDARDS

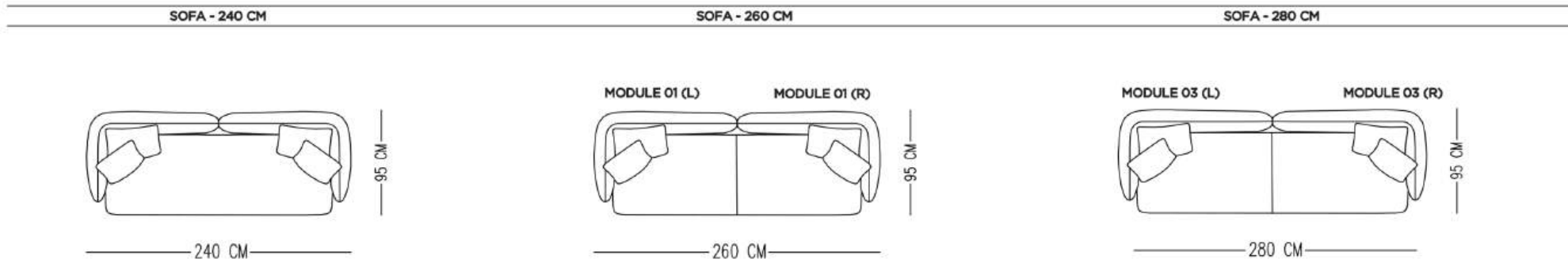

## MODULES

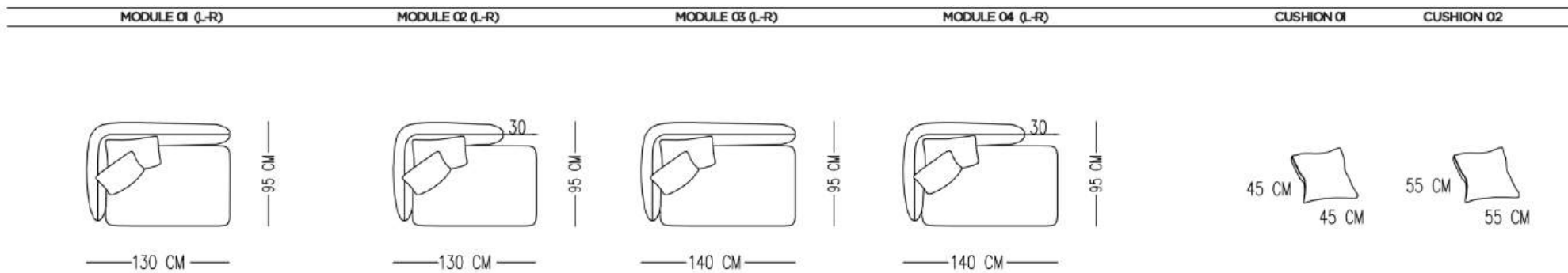

Catalog product-fabric

N-A20/Boucle  
01

Catalog product-Legs

Black Painted Metal

Alternative fabric  
Linen, Linen teddy, Suede and Boucle



## SOMET SOFA

### TECHNICAL SPECIFICATIONS

INTERIOR STRUCTURE      BEECH HARDWOOD FRAME AND STEEL ZIGZAG BOW

SEAT CUSHION              HR FOAM

BACK                        HR FOAM

UPHOLSTERY              TIGHT

MAINTENANCE            STANDART WITH 2 CUSHIONS

We recommend shaking and fluffing-up the cushions regularly to maintain the shape. This should be done after removing the cushions from the structure for improved air circulation. For maintenance of fabric and leather, please contact your retailer.

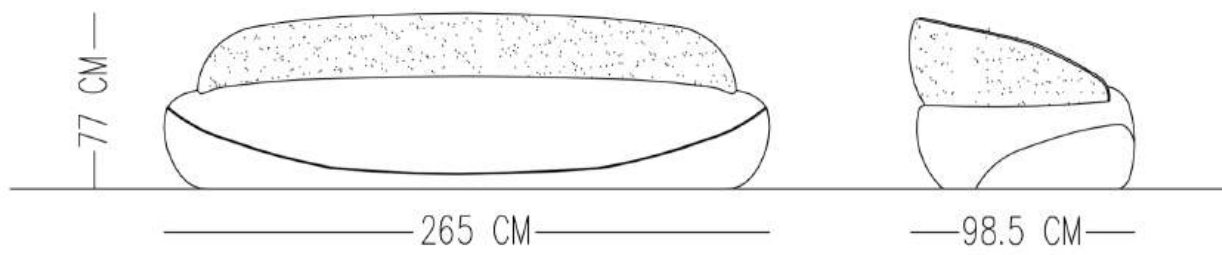

## STANDARDS

SOFA - 265 CM

CUSHION

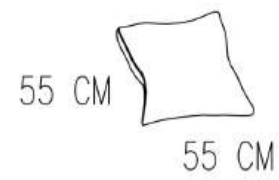
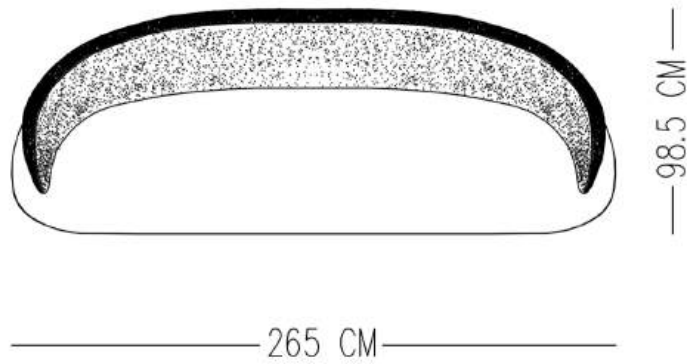

Catalog product-fabric

N-B34/Linen  
08

Catalog product-Legs

Hidden Leg

Alternative fabric  
Linen teddy, Boucle and Linen



# AUDREY SOFA

## TECHNICAL SPECIFICATIONS

INTERIOR STRUCTURE BEECH HARDWOOD FRAME AND ZIGZAG BOW

SEAT CUSHION HR FOAM

BACK HR FOAM

UPHOLSTERY TIGHT

LEGS ELECTROSTATIC POWDER BLACK PAINT ON METAL

MAINTENANCE ALL DECORATIVE CUSHIONS ARE GOOSE DOWN AND SILICON MIX, QUANTITY AND DIMENSIONS ARE AS PER TECHNICAL DRAWINGS. STANDART WITH 4 CUSHIONS

We recommend shaking and fluffing-up the cushions regularly to maintain the shape. This should be done after removing the cushions from the structure for improved air circulation. For maintenance of fabric and leather, please contact your retailer

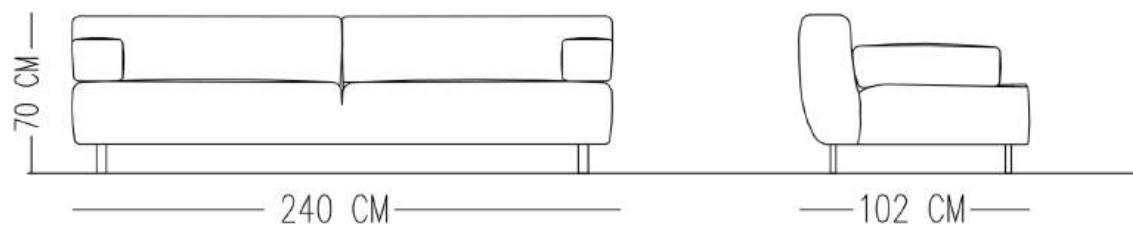

## STANDARDS

SOFA-240 CM	SOFA - 260 CM	CUSHION
-------------	---------------	---------

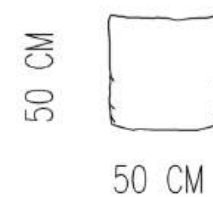
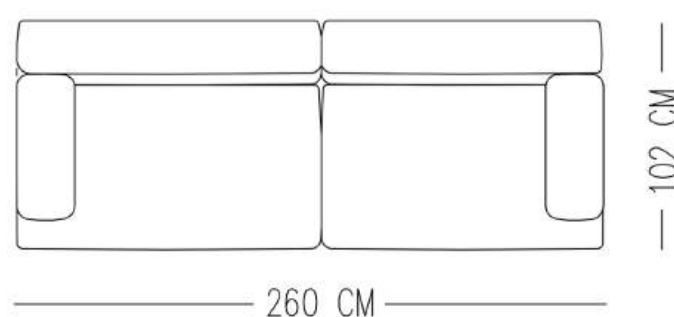
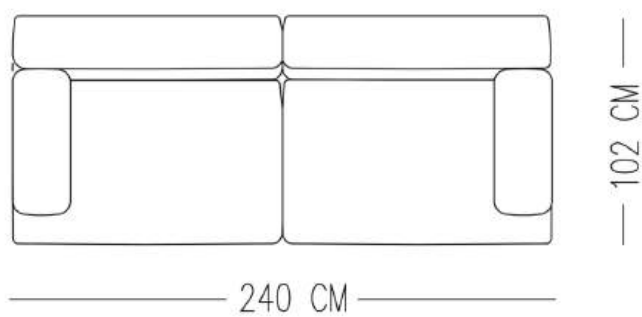

### Catalog product-fabric

N-B36 /Linen Teddy  
2002

### Catalog product-Legs

Electrostatic Powder Black Paint On Metal

Alternative fabric  
Linen,Boucle and Linen teddy



## VENEDIK SOFA

---

### TECHNICAL SPECIFICATIONS

---

INTERIOR STRUCTURE    BEECH HARDWOOD FRAME AND ELASTIC COLUMN

SEAT CUSHION    HR FOAM

BACK    HR FOAM

UPHOLSTERY    TIGHT

MAINTENANCE    ALL DECORATIVE CUSHIONS ARE GOOSE DOWN AND SILICON MIX, QUANTITY AND DIMENSIONS ARE AS PER TECHNICAL DRAWINGS. STANDART WITH 2 CUSHIONS 45\*45, 2 CUSHIONS 50\*50 .

We recommend shaking and fluffing-up the cushions regularly to maintain the shape. This should be done after removing the cushions from the structure for improved air circulation. For maintenance of fabric and leather, please contact your retailer.

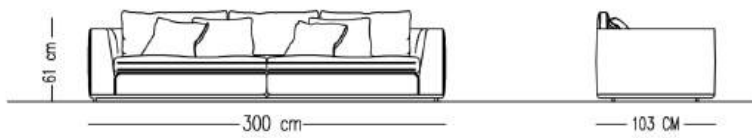

## STANDARDS

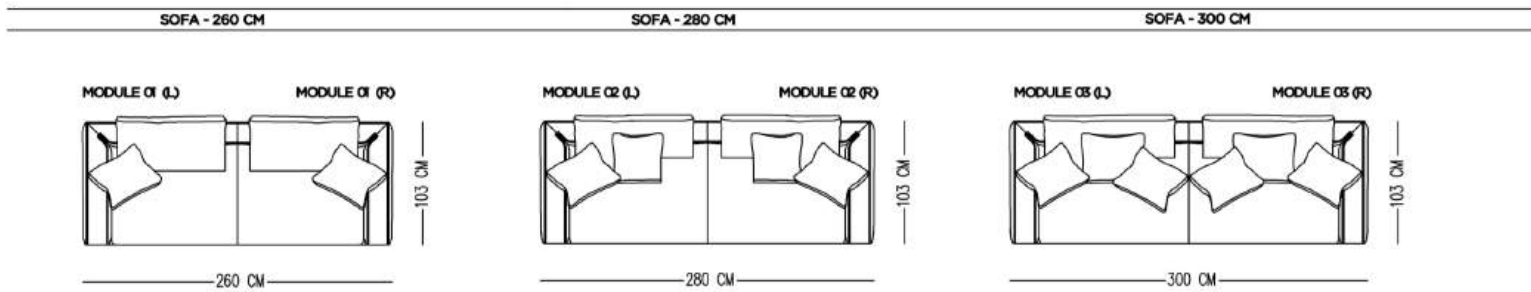

## MODULES

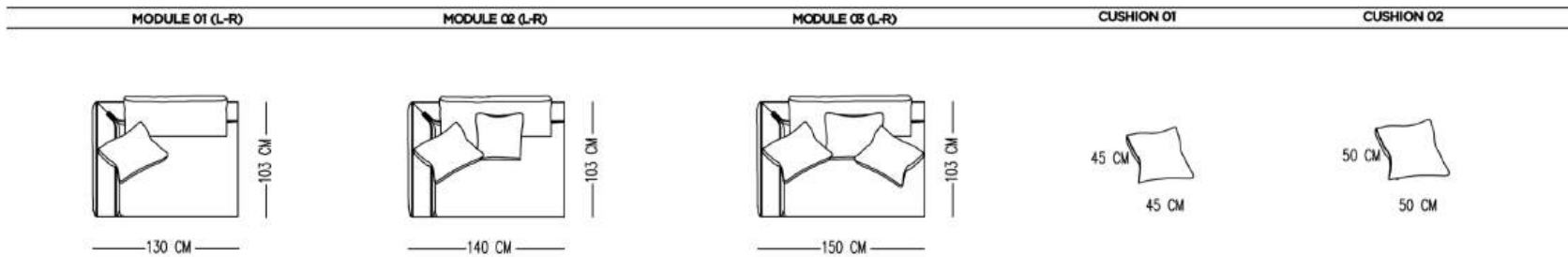

Catalog product-fabric

N-A10/Linen  
43850

Catalog product-Legs

Hidden Leg

Alternative fabric  
Linen, Boucle and Nubuck



## BİLGİN SOFA

### TECHNICAL SPECIFICATIONS

INTERIOR STRUCTURE BEECH HARDWOOD FRAME AND ELASTIC COLUMN

SEAT CUSHION HR FOAM

BACK HR FOAM

UPHOLSTERY TIGHT

MAINTENANCE ALL DECORATIVE CUSHIONS ARE GOOSE DOWN AND SILICON MIX. QUANTITY AND DIMENSIONS ARE AS PER TECHNICAL DRAWINGS. STANDART WITH 2 CUSHIONS 45\*90.

We recommend shaking and fluffing-up the cushions regularly to maintain the shape. This should be done after removing the cushions from the structure for improved air circulation. For maintenance of fabric and leather, please contact your retailer.

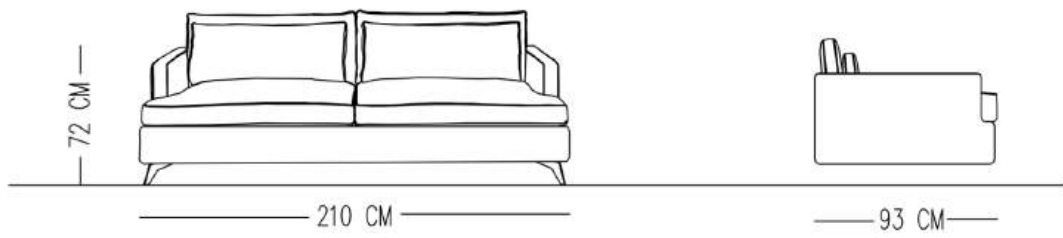

## STANDARDS

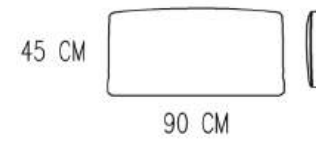
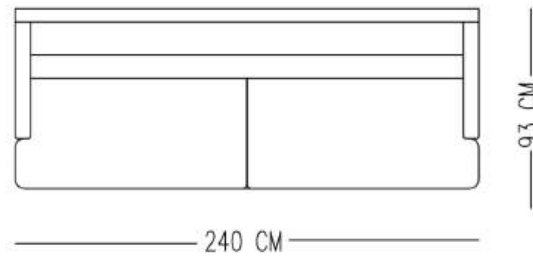
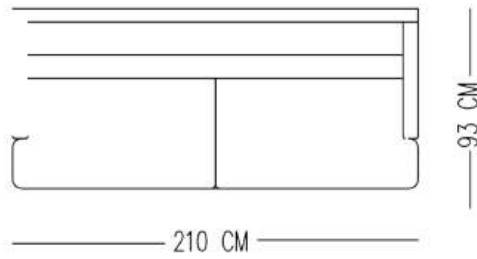

Catalog product-fabric

N-B34/Linen  
08

Catalog product-Legs

Black Metal

Alternative fabric  
Linen and Boucle



## PIETRA SOFA

### TECHNICAL SPECIFICATIONS

INTERIOR STRUCTURE    FRAME BEECH AND ELASTIC COLUMN

SEAT CUSHION    HR FOAM

BACK    HR FOAM

UPHOLSTERY    TIGHT

MAINTENANCE    ALL DECORATIVE CUSHIONS ARE GOOSE DOWN AND SILICON MIX, QUANTITY AND DIMENSIONS ARE AS PER TECHNICAL DRAWINGS. STANDART WITH 4 CUSHIONS 45\*45, 3 CUSHIONS 35\*50

We recommend shaking and fluffing-up the cushions regularly to maintain the shape. This should be done after removing the cushions from the structure for improved air circulation. For maintenance of fabric and leather, please contact your retailer.



## STANDARDS

SOFA - 220 CM

SOFA - 240 CM

CUSHION 01

CUSHION 02

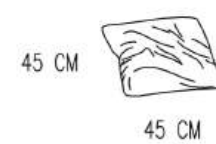
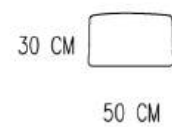
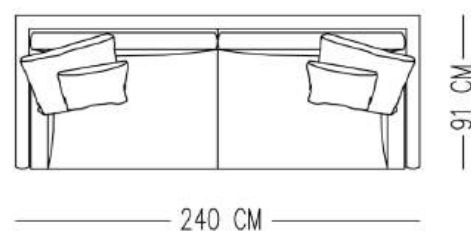
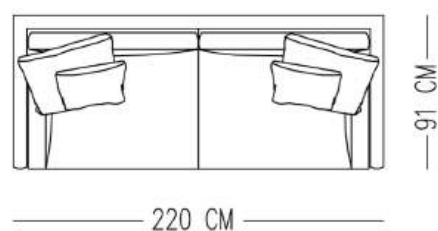

### Catalog product-fabric

N-B13/Linen  
A GRI - 01

### Catalog product-Legs

Black wood and brass old detail

Alternative fabric  
Linen and Boucle



## G60 CORNER SOFA

---

### TECHNICAL SPECIFICATIONS

---

INTERIOR STRUCTURE    BEECH HARDWOOD FRAME AND ZIGZAG BOW

SEAT CUSHION    HR FOAM

BACK    HR FOAM

UPHOLSTERY    TIGHT

MAINTENANCE    ALL DECORATIVE CUSHIONS ARE GOOSE DOWN AND SILICON MIX. QUANTITY AND DIMENSIONS ARE AS PER TECHNICAL.

We recommend shaking and fluffing-up the cushions regularly to maintain the shape. This should be done after removing the cushions from the structure for improved air circulation. For maintenance of fabric and leather, please contact your retailer.

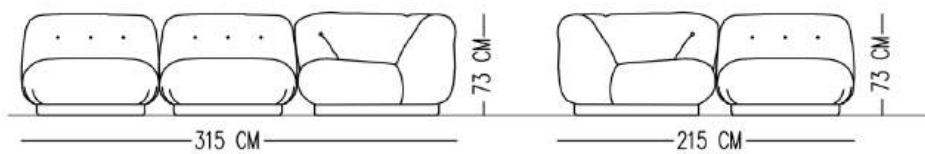

## STANDARDS

CORNER SOFA - 01 (L-R)

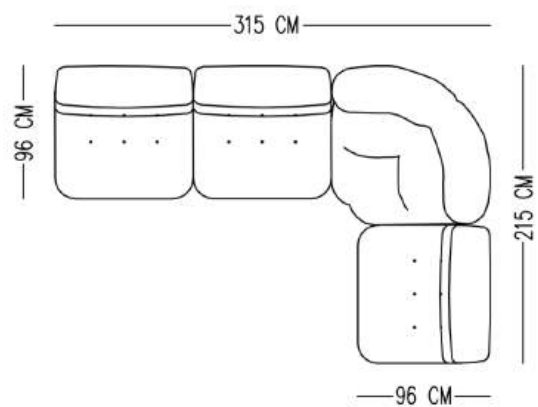

## MODULES

MODULE 01

MODULE 02 (L-R)

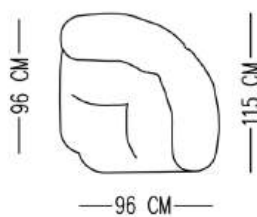
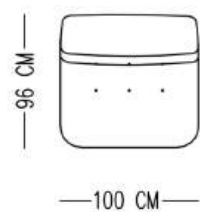

Catalog product-fabric  
N-B31  
9908

Alternative fabric  
Pisa teddy fabric

Catalog product-Legs  
Fabric Covering



## LYDIA CORNER SOFA

### TECHNICAL SPECIFICATIONS

INTERIOR STRUCTURE    BEECH HARDWOOD FRAME AND WOODEN BASE

SEAT CUSHION    HR FOAM

BACK    HR FOAM

UPHOLSTERY    TIGHT

MAINTENANCE    ALL DECORATIVE CUSHIONS ARE GOOSE DOWN AND SILICON MIX, QUANTITY AND DIMENSIONS ARE AS PER TECHNICAL. We recommend shaking and fluffing-up the cushions regularly to maintain the shape. This should be done after removing the cushions from the structure for improved air circulation. For maintenance of fabric and leather, please contact your retailer.

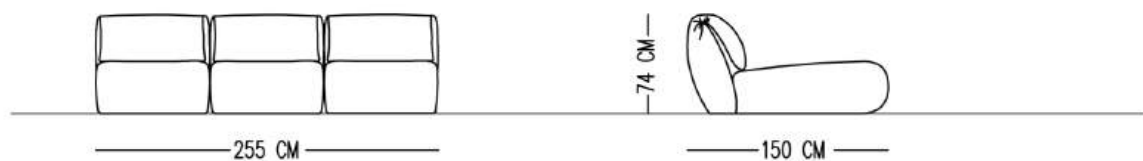

## STANDARDS

CORNER SOFA - 1

CORNER SOFA - 2

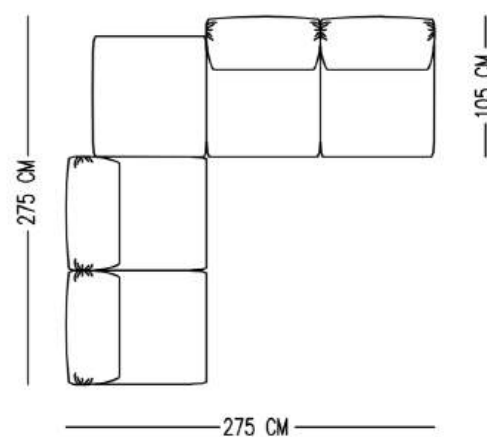
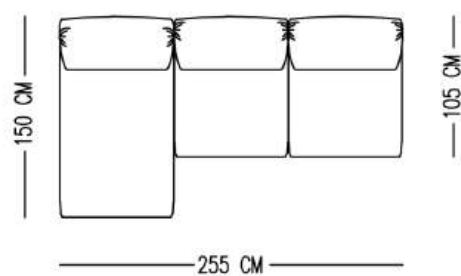

## MODULES

MODULE 01

MODULE 02 (L-R)

MODULE 03

MODULE 04

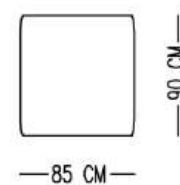
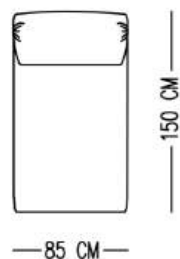
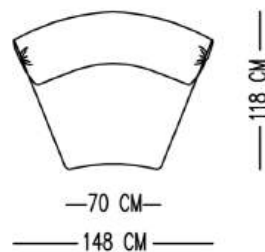
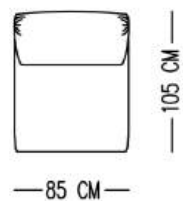

Catalog product-fabric  
Enjoy me-14

Alternative fabric  
Pisa teddy fabric



## NIORA CORNER SOFA

---

### TECHNICAL SPECIFICATIONS

---

INTERIOR STRUCTURE    BEECH HARDWOOD FRAME AND WOODEN BASE

SEAT CUSHION    HR FOAM

BACK    HR FOAM

UPHOLSTERY    TIGHT

MAINTENANCE    ALL DECORATIVE CUSHIONS ARE GOOSE DOWN AND SILICON MIX, QUANTITY AND DIMENSIONS ARE AS PER TECHNICAL. We recommend shaking and fluffing-up the cushions regularly to maintain the shape. This should be done after removing the cushions from the structure for improved air circulation. For maintenance of fabric and leather, please contact your retailer.

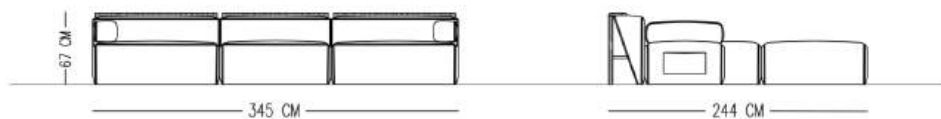

## STANDARDS

CORNER SOFA - 01

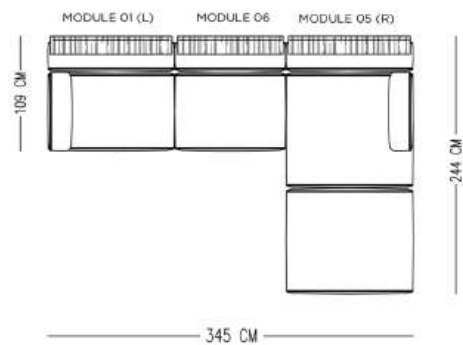

## MODULES

MODULE 01 (L-R)

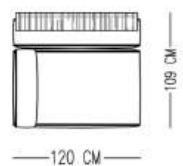

MODULE 02 (L-R)

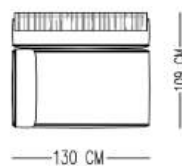

MODULE 03 (L-R)



MODULE 04 (L-R)

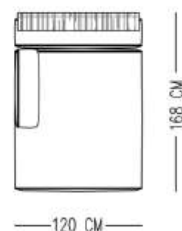

MODULE 05 (L-R)

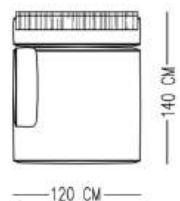

MODULE 06

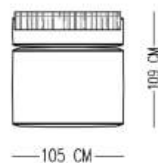

MODULE 07 (L-R)

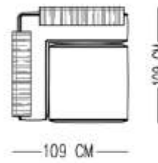

MODULE 08 (L-R)

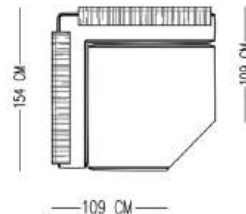

MODULE 09

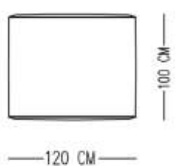

Catalog product-fabric  
Kinali-7

Catalog product-back  
N-02HP paint finish on oak  
wood Veneering (Matt)

Catalog product-Legs  
Hidden Leg

Alternative fabric  
Pisa teddy fabric



## TOPRAK CORNER SOFA

---

### TECHNICAL SPECIFICATIONS

---

INTERIOR STRUCTURE      BEECH HARDWOOD FRAME

SEAT CUSHION              HR FOAM

ARMREST                    PLEXY

UPHOLSTERY              TIGHT

**MAINTENANCE** ALL DECORATIVE CUSHIONS ARE GOOSE DOWN AND SILICON MIX, QUANTITY AND DIMENSIONS ARE AS PER TECHNICAL.  
We recommend shaking and fluffing-up the cushions regularly to maintain the shape.  
This should be done after removing the cushions from the structure for improved air circulation.  
For maintenance of fabric and leather, please contact your retailer.

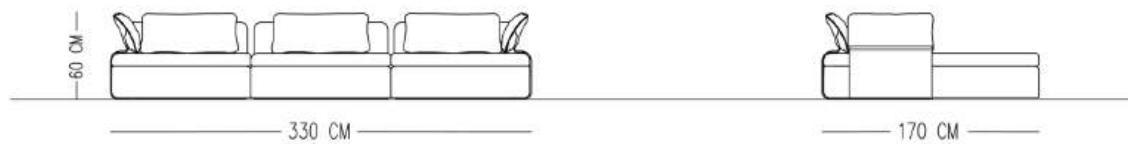

## STANDARDS

CORNER SOFA - 01

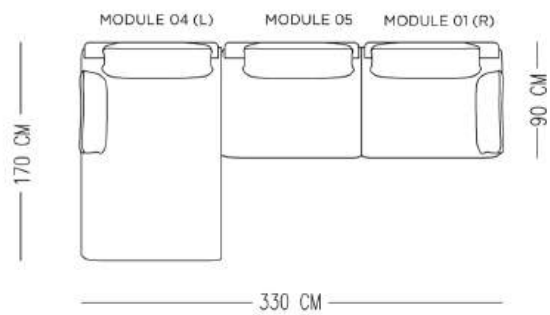

## MODULES

MODULE 01 (L-R)



MODULE 02 (L-R)

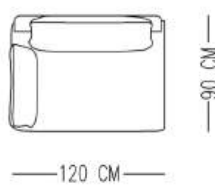

MODULE 03 (L-R)

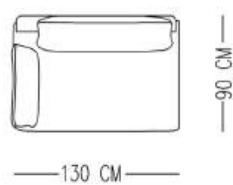

MODULE 04 (L-R)

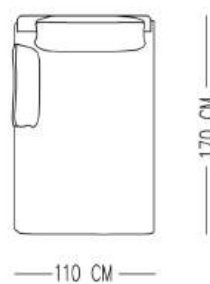

MODULE 05

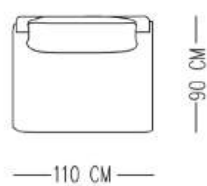

MODULE 06

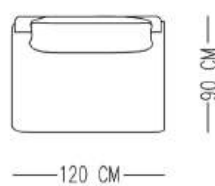

MODULE 07

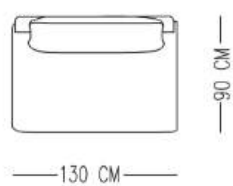

Catalog product-fabric  
Omerta-4282

Catalog product-arm  
Bronze plexy

Alternative fabric  
Pisa teddy fabric



## ME CORNER SOFA

---

### TECHNICAL SPECIFICATIONS

---

INTERIOR STRUCTURE	BEECH HARDWOOD FRAME AND ZIGZAG BOW
SEAT CUSHION	HR FOAM
BACK	HR FOAM
UPHOLSTERY	TIGHT
MAINTENANCE	ALL DECORATIVE CUSHIONS ARE GOOSE DOWN AND SILICON MIX, QUANTITY AND DIMENSIONS ARE AS PER TECHNICAL.

We recommend shaking and fluffing-up the cushions regularly to maintain the shape. This should be done after removing the cushions from the structure for improved air circulation. For maintenance of fabric and leather, please contact your retailer.

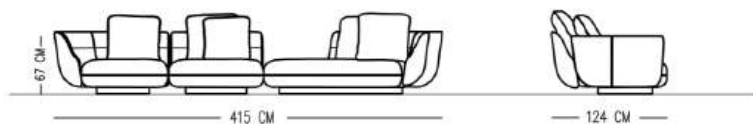

## STANDARDS

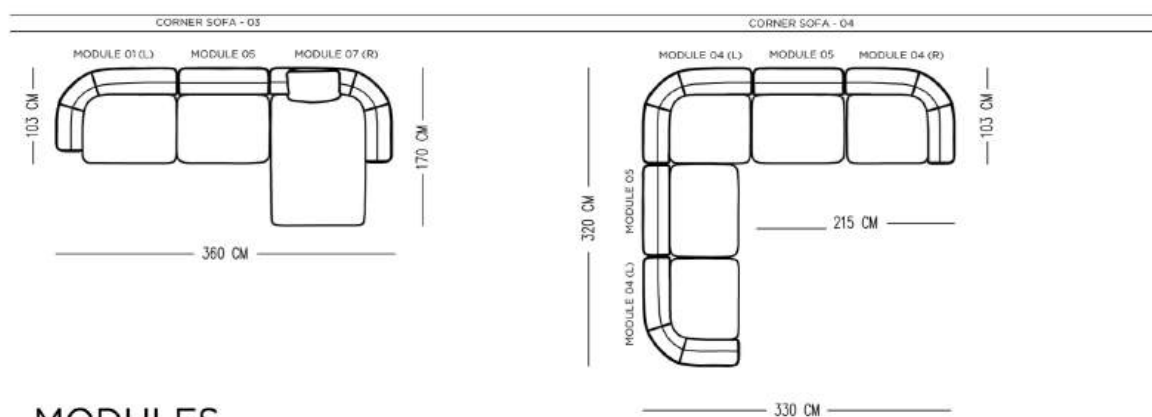
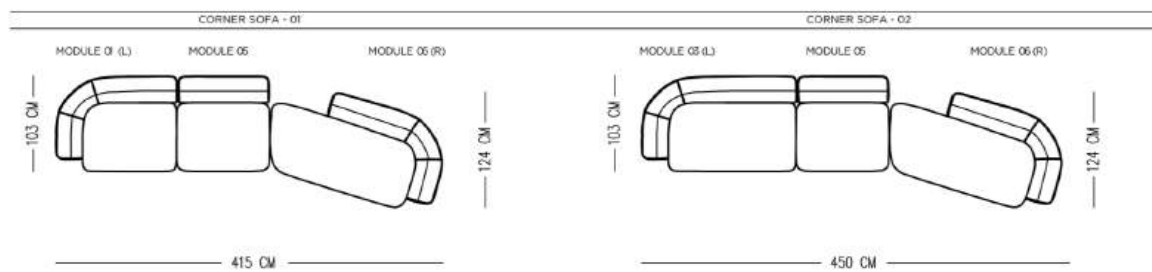

## MODULES

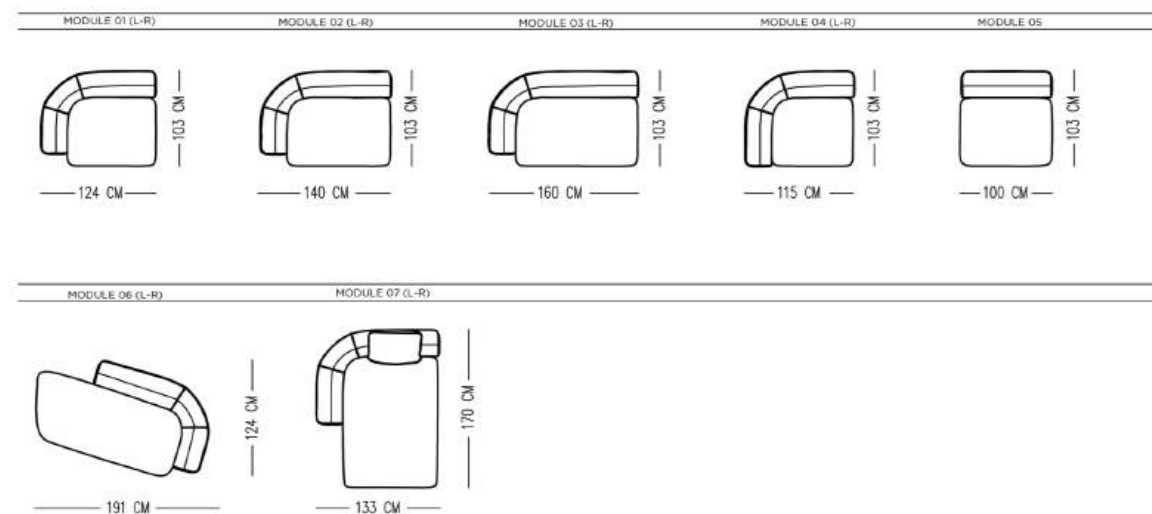

Catalog product-fabric

N-+A50/Linen  
14510

Back fabric

N-+A72/Leather  
Khaki

Catalog product-Legs

Laquer Painted On Wood (Matt)  
N-03K19

Alternative fabric

Linen, Linen teddy, Suede, Leather and  
Boucle



---

## RIVER CORNER SOFA

---

INTERIOR STRUCTURE    BEECH HARDWOOD FRAME AND ZIGZAG BOW

SEAT CUSHION    HR FOAM

BACK    HR FOAM

UPHOLSTERY    TIGHT

MAINTENANCE    ALL DECORATIVE CUSHIONS ARE GOOSE DOWN AND SILICON MIX, QUANTITY AND DIMENSIONS ARE AS PER TECHNICAL.

We recommend shaking and fluffing-up the cushions regularly to maintain the shape. This should be done after removing the cushions from the structure for improved air circulation. For maintenance of fabric and leather, please contact your retailer.

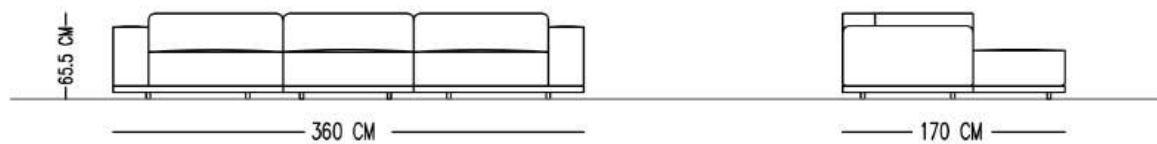

## STANDARDS

CORNER SOFA - 01

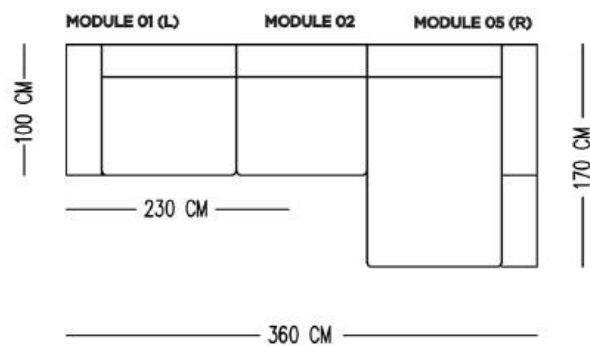

## MODULES

MODULE 01 (L-R)

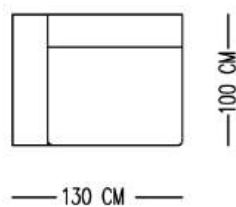

MODULE 02

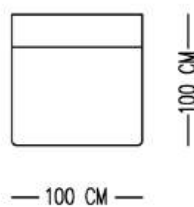

MODULE 03 (L-R)

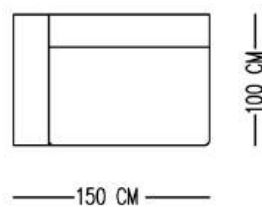

MODULE 04 (S)

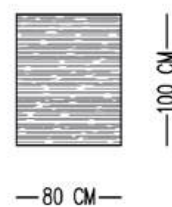

MODULE 05 (L-R)

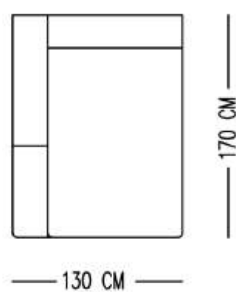

CORNER - MODULE 06 (L-R)

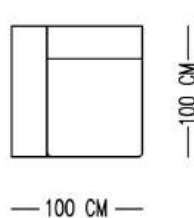

MODULE 07 (L-R)

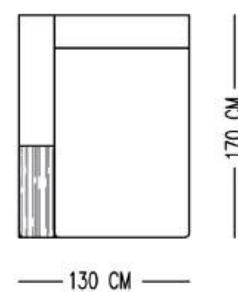

Catalog product-fabric  
N-A10/Linen  
40443

Coffee Table  
Oak veneering with bitter  
brown varnish

Base  
Leather

Catalog product-Legs  
Black Leg

Alternative fabric  
Linen and Boucle



---

## ROSA CORNER SOFA

---

INTERIOR STRUCTURE    BEECH HARDWOOD FRAME AND ZIGZAG BOW

SEAT CUSHION    HR FOAM

BACK    HR FOAM

UPHOLSTERY    TIGHT

MAINTENANCE    ALL DECORATIVE CUSHIONS ARE GOOSE DOWN AND SILICON MIX. QUANTITY AND DIMENSIONS ARE AS PER TECHNICAL.

We recommend shaking and fluffing-up the cushions regularly to maintain the shape. This should be done after removing the cushions from the structure for improved air circulation. For maintenance of fabric and leather, please contact your retailer.

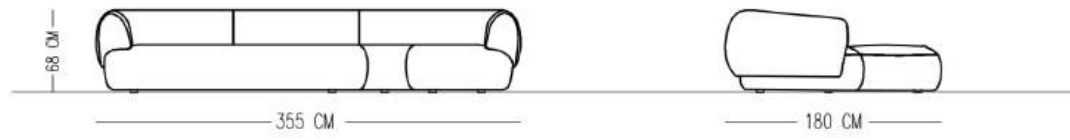

## STANDARDS

CORNER SOFA - 01

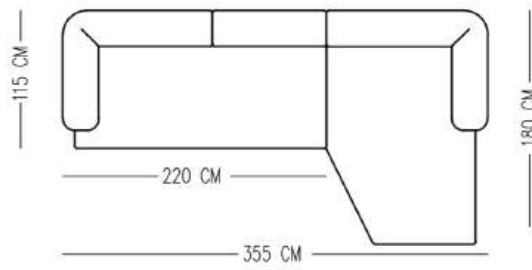

## MODULES

MODULE 03 (L-R)

MODULE 04 (L-R)

MODULE 05 (L-R)

MODULE 06 (L-R)

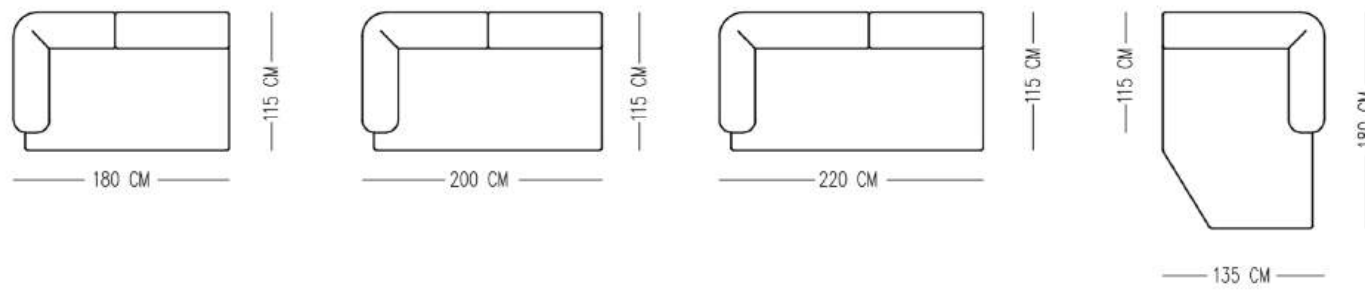

Catalog product-fabric  
N+A81/Linen  
179300

Catalog product-Legs  
Hidden leg



## AUDREY CORNER SOFA

### TECHNICAL SPECIFICATIONS

INTERIOR STRUCTURE BEECH HARDWOOD FRAME AND ZIGZAG BO W

SEAT CUSHION HR FOAM

BACK HR FOAM

UPHOLSTERY TIGHT

LEGS ELECTROSTATIC POWDER BLACK PAINT ON METAL

MAINTENANCE ALL DECORATIVE CUSHIONS ARE GOOSE DOWN AND SILICON MIX. QUANTITY AND DIMENSIONS ARE AS PER TECHNICAL DRAWINGS. STANDART WITH 4 CUSHIONS

We recommend shaking and fluffing-up the cushions regularly to maintain the shape. This should be done after removing the cushions from the structure for improved air circulation. For maintenance of fabric and leather, please contact your retailer.

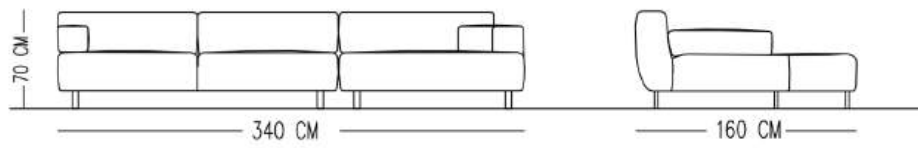

## STANDARDS

CORNER SOFA - 340 CM

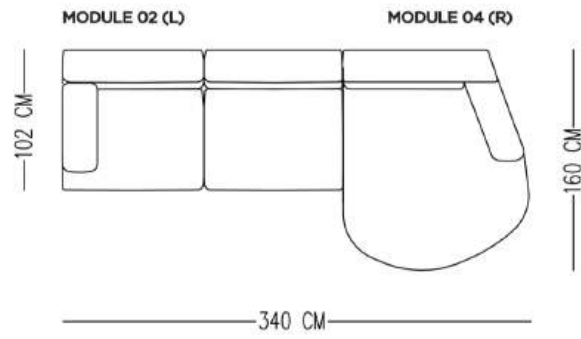

## MODULES

MODULE 01 (L-R)

MODULE 02 (L-R)

MODULE 03 (L-R)

MODULE 04 (L-R)

CUSHION

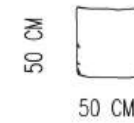
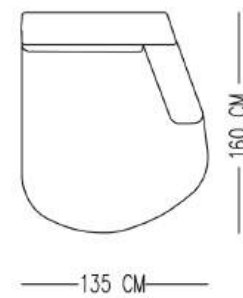
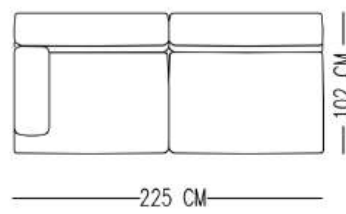
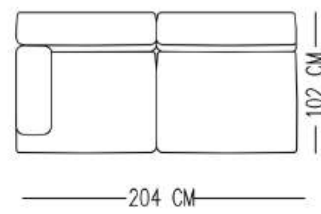
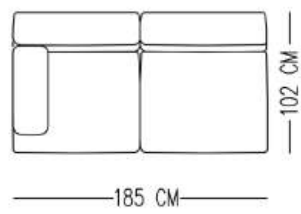

Catalog product-fabric  
N-A57/Linen Velvet  
5048

Catalog product-Legs  
Electrostatic Powder  
Black Paint On Metal

Alternative fabric  
Linen, Boucle and Linen teddy



## DOMINO CORNER SOFA

---

### TECHNICAL SPECIFICATIONS

---

INTERIOR STRUCTURE    BEECH HARDWOOD FRAME

SEAT CUSHION    HR FOAM

BACK    HR FOAM

UPHOLSTERY    TIGHT

MAINTENANCE    ALL DECORATIVE CUSHIONS ARE GOOSE DOWN AND SILICON MIX, QUANTITY AND DIMENSIONS ARE AS PER TECHNICAL.

We recommend shaking and fluffing-up the cushions regularly to maintain the shape. This should be done after removing the cushions from the structure for improved air circulation. For maintenance of fabric and leather, please contact your retailer.

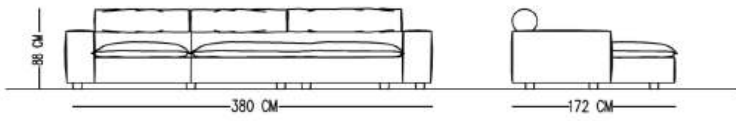

## STANDARDS

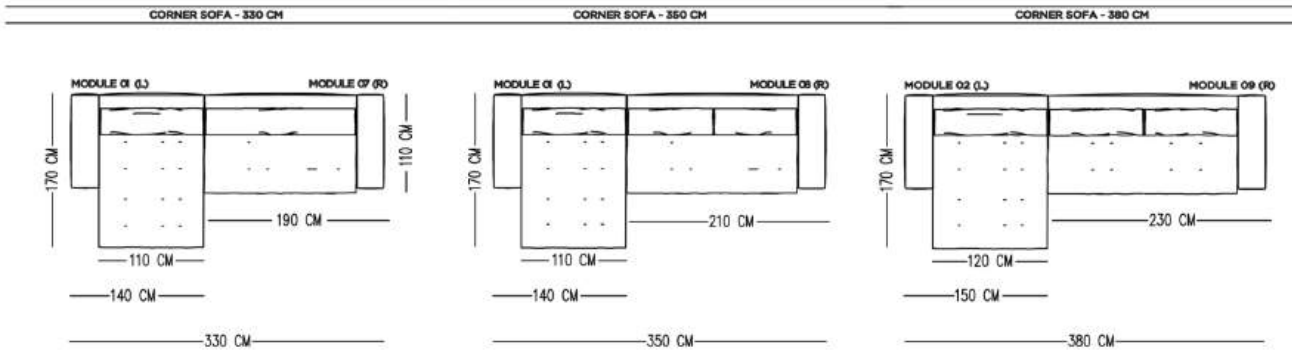

## MODULES

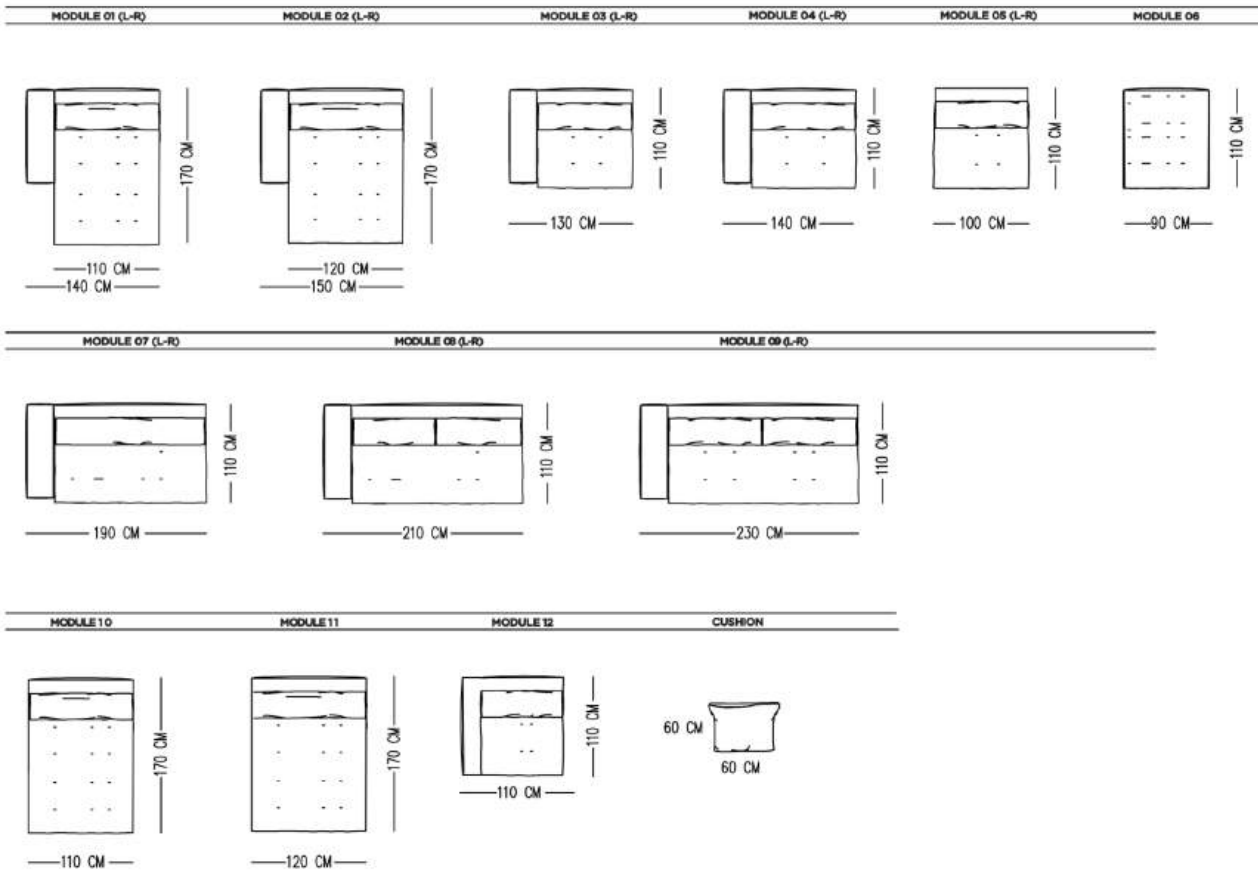

Catalog product-fabric

N-A17/Nubuck  
048

Catalog product-Legs

Hidden Leg

Alternative fabric  
Linen,Soft velvet and Nubuck



## BULUT CORNER SOFA

### TECHNICALS PECIFICATIONS

INTERIOR STRUCTURE BEECH WOOD AND STEEL AND MDF WITH ZIGZAG BOW

STRUCTURE PADDING HR FOAM

SEAT CUSHION HR FOAM

BACK BACK CUSHION 100% DOWN/FEATHERS

UPHOLSTERY LOOSE

MAINTENANCE ALL DECORATIVE CUSHIONS ARE GOOSE DOWN AND SILICON MIX, QUANTITY AND DIMENSIONS ARE AS PER TECHNICAL DRAWINGS. STANDART WITH 2 CUSHIONS 60\*60, 2 CUSHIONS 45\*45, 1 CUSHIONS 35\*55.

We recommend shaking and fluffing-up the cushions regularly to maintain the shape.

This should be done after removing the cushions from the structure for improved air circulation.

For maintenance of fabric and leather, please contact your retailer

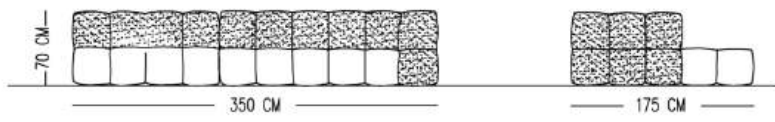

## STANDARDS

CORNER SOFA - 350 CM

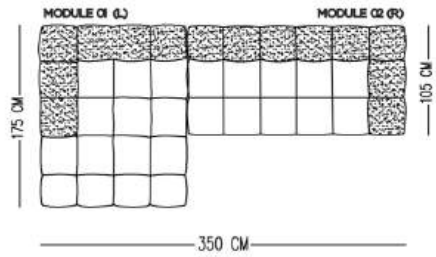

## MODULES

MODULE 01 (L-R)

MODULE 02 (L-R)

MODULE 03 (L-R)

MODULE 04 (L-R)

MODULE 05 (L-R)

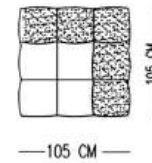
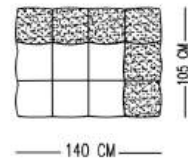
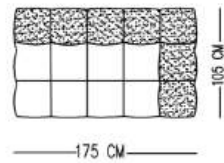
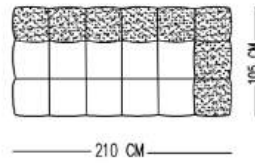
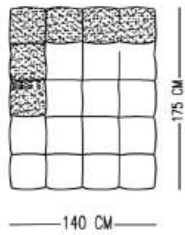

MODULE 06 (L-R)

MODULE 06

MODULE 07 (P)

CUSHION 01

CUSHION 02

CUSHION 03

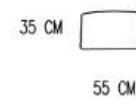
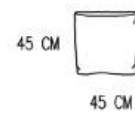
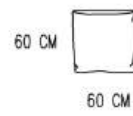
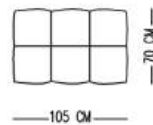
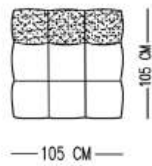
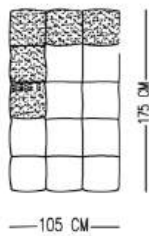

Catalog product-fabric

N-A16/Teddy  
46860

Catalog product-Legs

Hidden Leg

Alternative fabric  
Linen teddy, Suede, Linen and Boucle



## VIBE CORNER SOFA

### TECHNICAL SPECIFICATIONS

INTERIOR STRUCTURE BEECH HARDWOOD FRAME AND ZIGZAG BOW

SEAT CUSHION HR FOAM

BACK HR FOAM

UPHOLSTERY TIGHT

MAINTENANCE ALL DECORATIVE CUSHIONS ARE GOOSE DOWN AND SILICON MIX, QUANTITY AND DIMENSIONS ARE AS PER TECHNICAL DRAWINGS. STANDART WITH 4 CUSHIONS

We recommend shaking and fluffing-up the cushions regularly to maintain the shape. This should be done after removing the cushions from the structure for improved air circulation. For maintenance of fabric and leather, please contact your retailer.



## STANDARDS

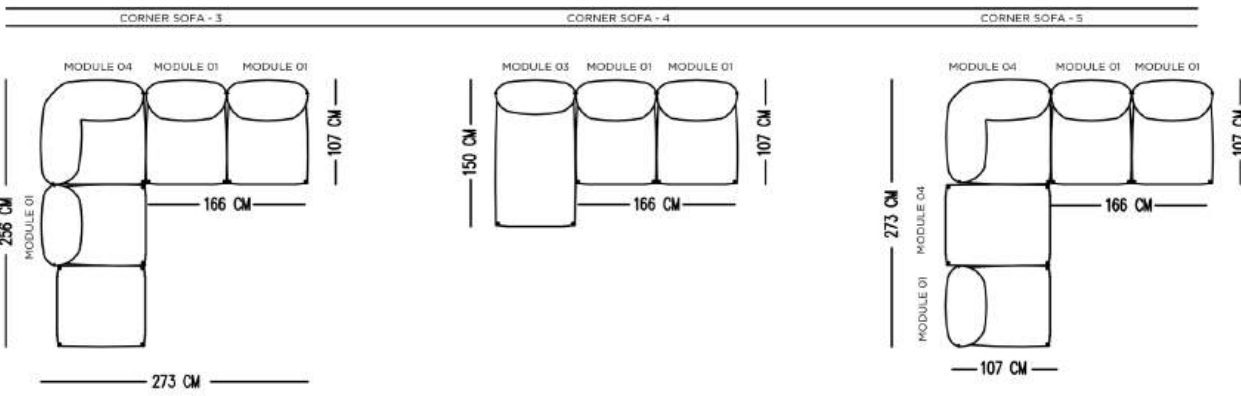
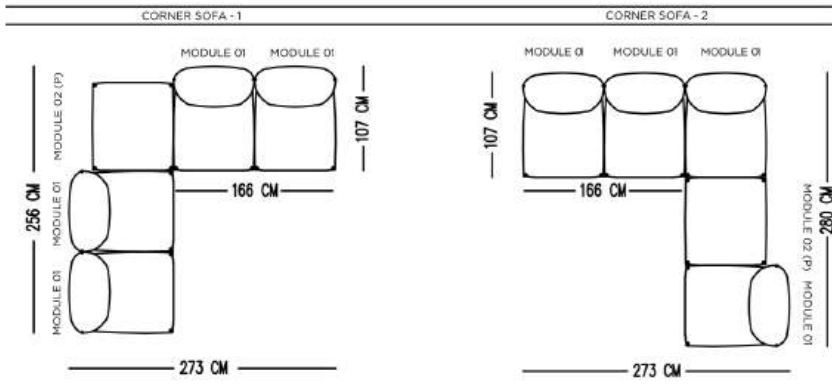

## MODULES

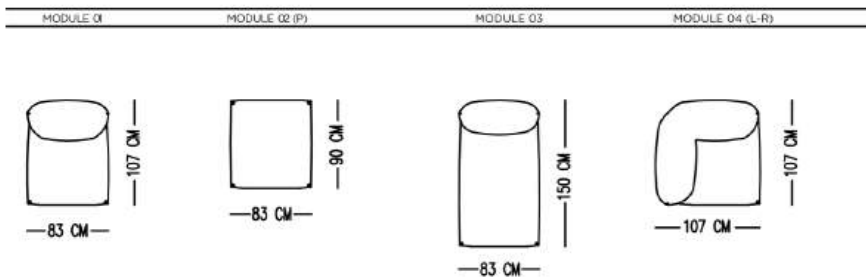

Catalog product-fabric

N+A47/ Boucle  
14500

Catalog product-Legs

Hidden leg

Alternative fabric  
Linen, Boucle and Linen teddy



## FRAME CORNER SOFA

---

### TECHNICAL SPECIFICATIONS

---

INTERIOR STRUCTURE BEECH HARDWOOD FRAME AND ZIGZAG BOW

SEAT CUSHION HR FOAM

BACK HR FOAM

UPHOLSTERY TIGHT

MAINTENANCE ALL DECORATIVE CUSHIONS ARE GOOSE DOWN AND SILICON MIX. QUANTITY AND DIMENSIONS ARE AS PER TECHNICAL DRAWINGS. STANDART WITH 6 CUSHIONS 55\*55.

We recommend shaking and fluffing-up the cushions regularly to maintain the shape. This should be done after removing the cushions from the structure for improved air circulation. For maintenance of fabric and leather, please contact your retailer.



## STANDARDS

### CORNER SOFA - 1

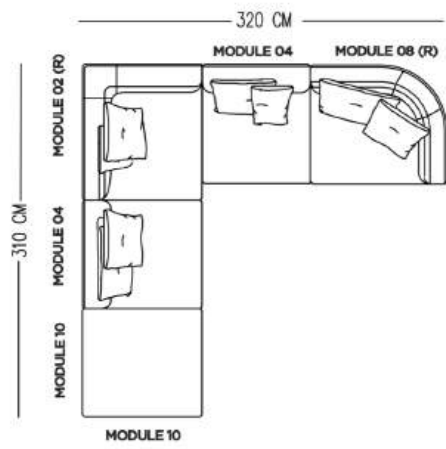

MODULE 01 (L-R)

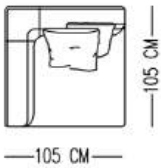

MODULE 02 (L-R)

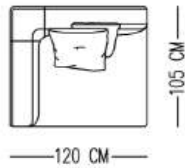

MODULE 03 (L-R)

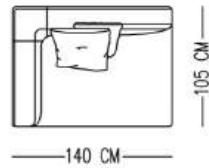

MODULE 04

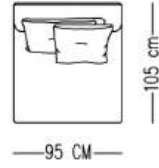

MODULE 05

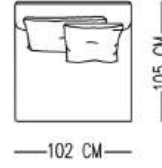

MODULE 06



MODULE 07 (L-R)

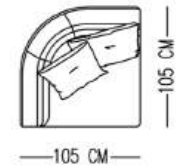

MODULE 08 (L-R)

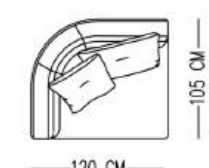

MODULE 09 (L-R)



MODULE 10

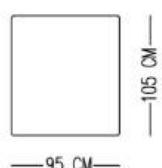

CUSHION 01

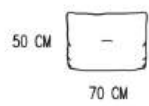

CUSHION 02

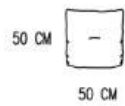

### Catalog product-fabric

N-B11/Linen  
2103

### Catalog product-Legs

Hidden Leg

Alternative fabric  
Linen, Boucle and Nubuck



## ITALS CORNER SOFA

---

### TECHNICAL SPECIFICATIONS

---

INTERIOR STRUCTURE    BEECH HARDWOOD FRAME AND ELASTIC COLUMN

SEAT CUSHION    HR FOAM

BACK    HR FOAM

UPHOLSTERY    TIGHT

MAINTENANCE    ALL DECORATIVE CUSHIONS ARE GOOSE DOWN AND SILICON MIX. QUANTITY AND DIMENSIONS ARE AS PER TECHNICAL DRAWINGS. STANDART WITH 3 CUSHIONS - 25\*55. 1 CUSHIONS 45\*45

We recommend shaking and fluffing-up the cushions regularly to maintain the shape. This should be done after removing the cushions from the structure for improved air circulation. For maintenance of fabric and leather, please contact your retailer.

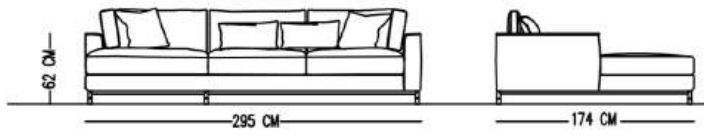

## STANDARDS

CORNER SOFA - 295 CM

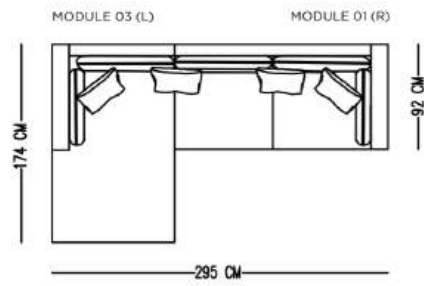

## MODULES

MODULE 01 (L-R)

MODULE 02 (L-R)

MODULE 03 (L-R)

MODULE 04 (L-R)

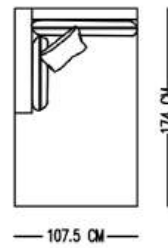
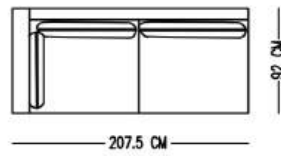
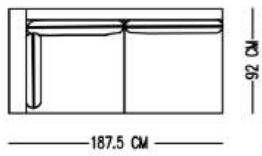

MODULE 05 (L-R)

MODULE 06 (L-R)

CUSHION 01

CUSHION 02

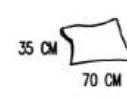
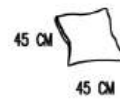
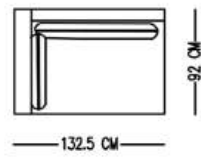
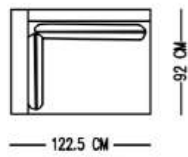

Catalog product-fabric

Catalog product-Legs  
Chromium

Etna 3

Alternative fabric  
Linen and Boucle



## PORTO CORNER SOFA

---

### TECHNICAL SPECIFICATIONS

---

INTERIOR STRUCTURE BEECH HARDWOOD FRAME AND ELASTIC COLUMN

SEAT CUSHION HR FOAM

BACK HR FOAM

UPHOLSTERY TIGHT

MAINTENANCE ALL DECORATIVE CUSHIONS ARE GOOSE DOWN AND SILICON MIX, QUANTITY AND DIMENSIONS ARE AS PER TECHNICAL DRAWINGS. STANDART WITH 4 CUSHIONS 60\*60

We recommend shaking and fluffing-up the cushions regularly to maintain the shape. This should be done after removing the cushions from the structure for improved air circulation. For maintenance of fabric and leather, please contact your retailer.

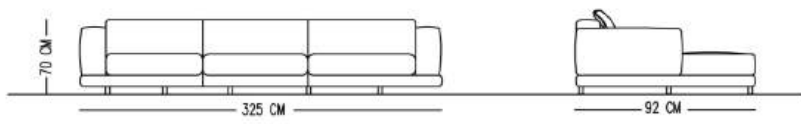

## STANDARDS

### CORNER SOFA - 325 CM

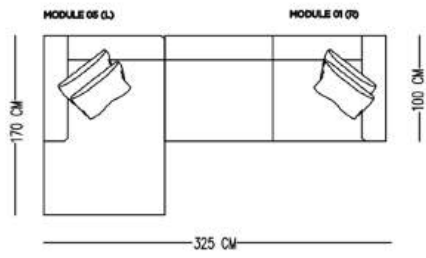

## MODULES

### MODULE 01 (L-R)      MODULE 02 (L-R)      MODULE 03      MODULE 04 (L-R)

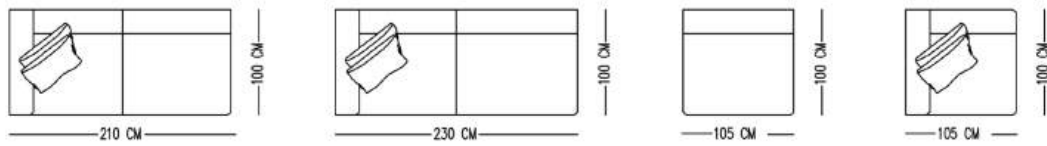

### MODULE 05 (L-R)      CUSHION 01      CUSHION 02

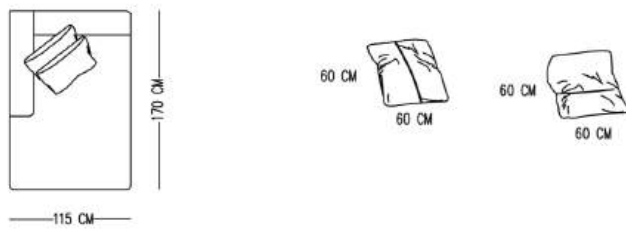

Catalog product-fabric

N-B39/Linen  
2134

Catalog product-Legs

Black Painted Metal

Alternative fabric  
Linen and Boucle



# ANGE CORNER SOFA

## TECHNICAL SPECIFICATIONS

INTERIOR STRUCTURE	BEECH WOOD AND ELASTIC COLUMN
SEAT CUSHION	HR FOAM
BACK	HR FOAM
UPHOLSTERY	TIGHT
MAINTENANCE	<p>ALL DECORATIVE CUSHIONS ARE GOOSE DOWN AND SILICON MIX, QUANTITY AND DIMENSIONS ARE AS PER TECHNICAL DRAWINGS. STANDART WITH 3 CUSHIONS 55*55, 3 CUSHIONS 45*45.</p> <p>We recommend shaking and fluffing-up the cushions regularly to maintain the shape. This should be done after removing the cushions from the structure for improved air circulation. For maintenance of fabric and leather, please contact your retailer.</p>

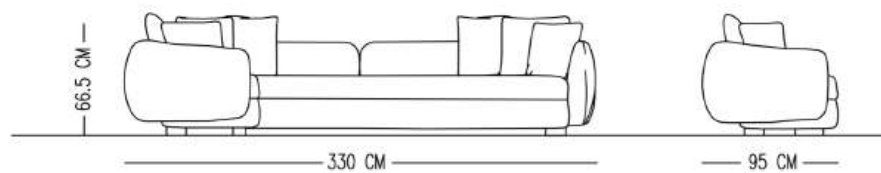

## STANDARDS

CORNER SOFA - 330 CM

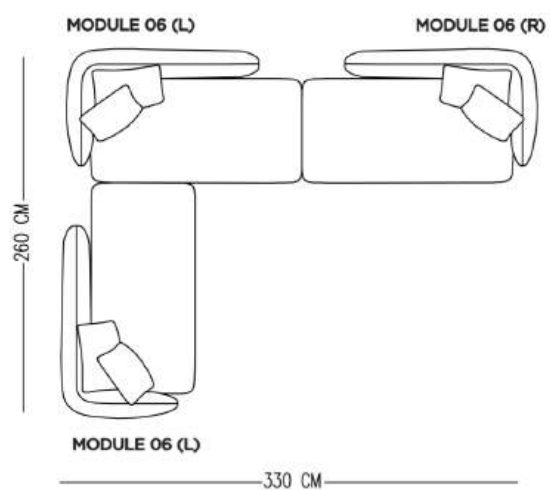

## MODULES

MODULE 03 (L-R)

MODULE 04 (L-R)

MODULE 05 (L-R)

MODULE 06 (L-R)

CUSHION 01

CUSHION 02

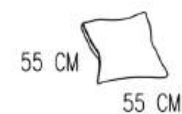
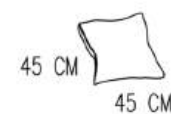
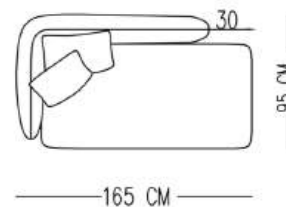
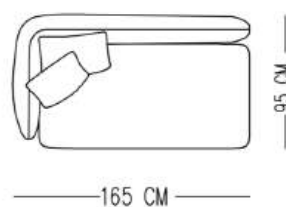
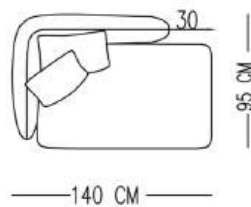
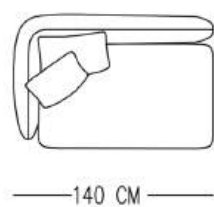

Catalog product-fabric

N-+A11/Boucle  
53323

Catalog product-Legs

Black Painted Metal

Alternative fabric  
Linen, Linen teddy, Suede and Boucle



## PIETRA CORNER SOFA

### TECHNICAL SPECIFICATIONS

INTERIOR STRUCTURE    FRAME BEECH AND ELASTIC COLUMN

SEAT CUSHION    HR FOAM

BACK    HR FOAM

UPHOLSTERY    TIGHT

MAINTENANCE    ALL DECORATIVE CUSHIONS ARE GOOSE DOWN AND SILICON MIX, QUANTITY AND DIMENSIONS ARE AS PER TECHNICAL DRAWINGS. STANDART WITH 4 CUSHIONS 45\*45, 3 CUSHIONS 35\*50

We recommend shaking and fluffing-up the cushions regularly to maintain the shape. This should be done after removing the cushions from the structure for improved air circulation. For maintenance of fabric and leather, please contact your retailer.

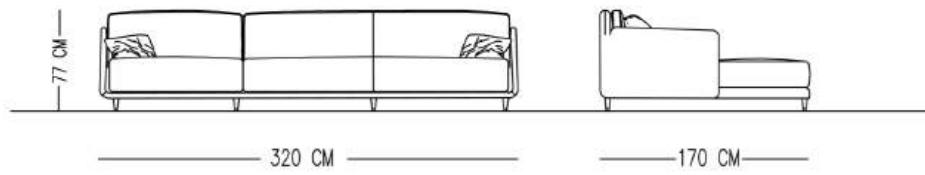

## STANDARDS

CORNER SOFA - 320 CM

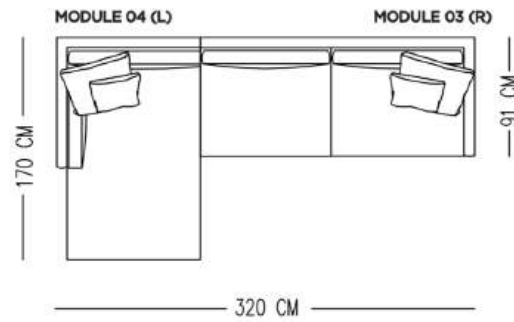

## MODULES

MODULE 01 (L-R)

MODULE 02 (L-R)

MODULE 03 (L-R)

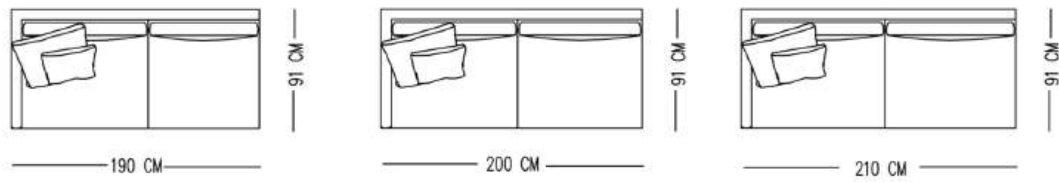

MODULE 04 (L-R)

CUSHION 01

CUSHION 02

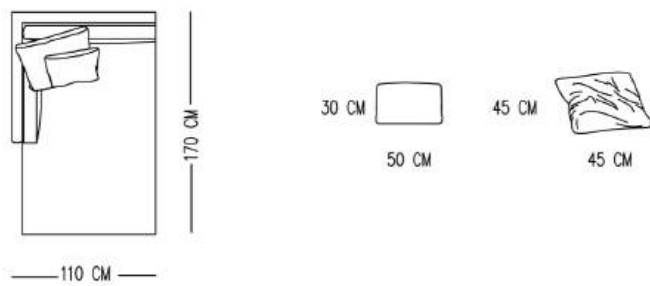

Catalog product-fabric

N-B32/Linen  
213-13

Catalog product-Legs

Wood black and brass  
old detail

Alternative fabric  
Linen and Boucle