

SOFAS & CORNER SOFAS

SitForm.
redefine your space





G.60 SOFA

TECHNICAL SPECIFICATIONS

INTERIOR STRUCTURE BEECH HARDWOOD FRAME AND ZIGZAG BOW

SEAT CUSHION HR FOAM

BACK HR FOAM

UPHOLSTERY TIGHT

MAINTENANCE ALL DECORATIVE CUSHIONS ARE GOOSE DOWN AND SILICON MIX, QUANTITY AND DIMENSIONS ARE AS PER TECHNICAL.

We recommend shaking and fluffing-up the cushions regularly to maintain the shape. This should be done after removing the cushions from the structure for improved air circulation. For maintenance of fabric and leather, please contact your retailer.

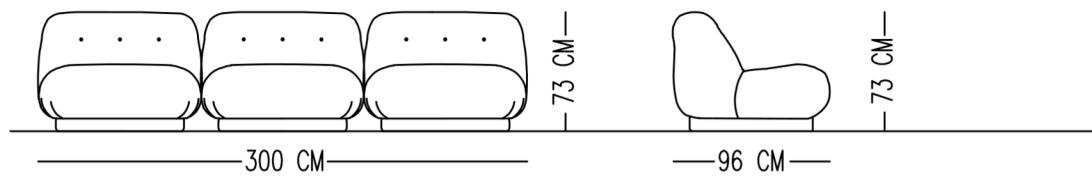

STANDARDS

SOFA - 300 CM

SOFA - 430 CM

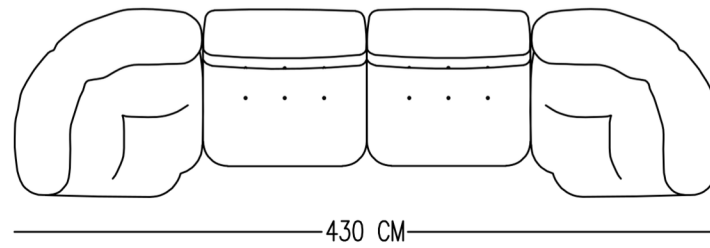
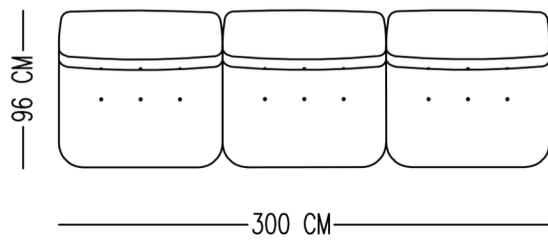

MODULES

MODULE 01

MODULE 02 (L-R)

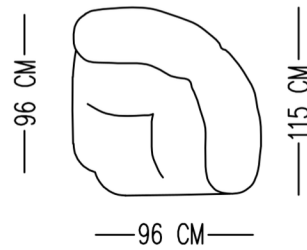
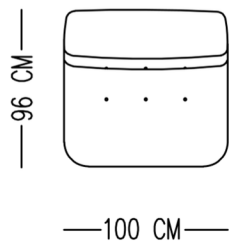

Catalog product-fabric
Pisa 05

Catalog product-Legs
Fabric Covering

Alternative fabric
Pisa teddy fabric



TOPRAK SOFA

TECHNICAL SPECIFICATIONS

INTERIOR STRUCTURE

BEECH HARDWOOD FRAME

SEAT CUSHION

HR FOAM

ARMREST

PLEXY

UPHOLSTERY

TIGHT

MAINTENANCE

ALL DECORATIVE CUSHIONS ARE GOOSE DOWN AND SILICON MIX, QUANTITY AND DIMENSIONS ARE AS PER TECHNICAL.

We recommend shaking and fluffing-up the cushions regularly to maintain the shape. This should be done after removing the cushions from the structure for improved air circulation. For maintenance of fabric and leather, please contact your retailer.

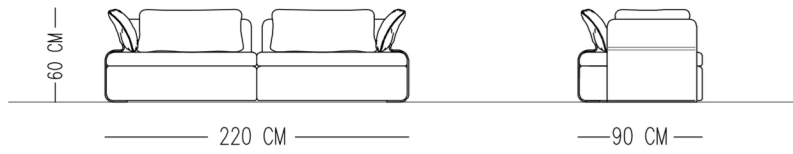

STANDARDS

SOFA - 220 CM

SOFA - 240 CM

SOFA - 260 CM

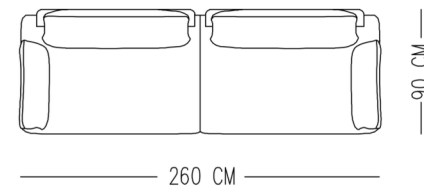
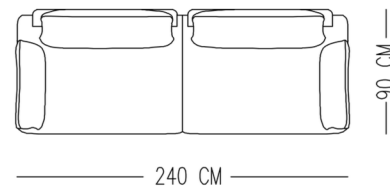
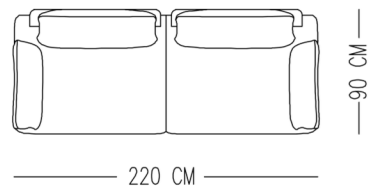

MODULES

MODULE 01 (L-R)

MODULE 02 (L-R)

MODULE 03 (L-R)

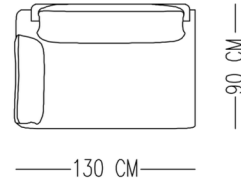
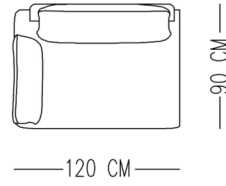
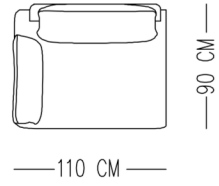

Catalog product-fabric
Omerta-4282

Catalog product-Arm
Bronze plexy

Alternative fabric
Linen, Linen teddy, Suede, Leather and
Boucle



NIORA SOFA

TECHNICAL SPECIFICATIONS

INTERIOR STRUCTURE

BEECH PLYWOOD FRAME

SEAT CUSHION

HR FOAM

BACK

HR FOAM

UPHOLSTERY

TIGHT

MAINTENANCE

ALL DECORATIVE CUSHIONS ARE GOOSE DOWN AND SILICON MIX, QUANTITY AND DIMENSIONS ARE AS PER TECHNICAL.

We recommend shaking and fluffing-up the cushions regularly to maintain the shape. This should be done after removing the cushions from the structure for improved air circulation. For maintenance of fabric and leather, please contact your retailer.

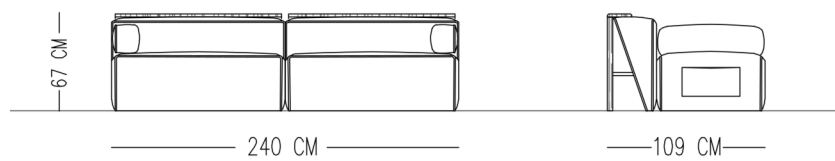

STANDARDS

SOFA - 240 CM

SOFA - 260 CM

SOFA - 280 CM

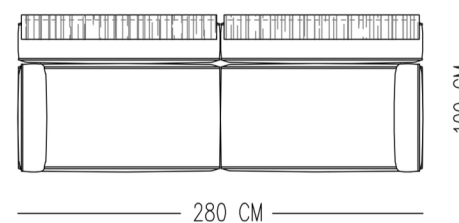
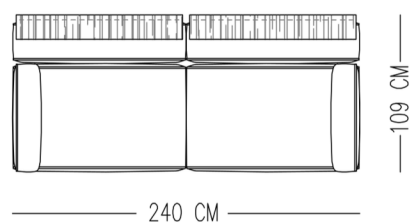

MODULES

MODULE 01 (L-R)

MODULE 02 (L-R)

MODULE 03 (L-R)

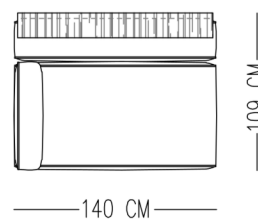
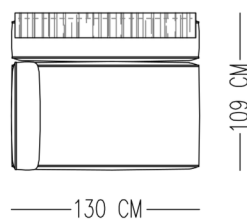
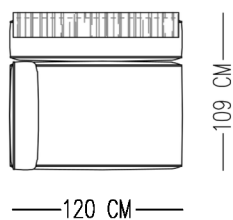

Catalog product-fabric
Kinali-7

Back fabric
N-02HP paint finish on
oak wood Veneering (Matt)

Alternative fabric
Linen, Linen teddy, Suede, Leather and
Boucle



LYDIA SOFA

TECHNICAL SPECIFICATIONS

INTERIOR STRUCTURE

BEECH HARDWOOD FRAME AND WOODEN BASE

SEAT CUSHION

HR FOAM

BACK

HR FOAM

UPHOLSTERY

TIGHT

MAINTENANCE

ALL DECORATIVE CUSHIONS ARE GOOSE DOWN AND SILICON MIX, QUANTITY AND DIMENSIONS ARE AS PER TECHNICAL.

We recommend shaking and fluffing-up the cushions regularly to maintain the shape. This should be done after removing the cushions from the structure for improved air circulation. For maintenance of fabric and leather, please contact your retailer.



MATH SOFA

TECHNICAL SPECIFICATIONS

INTERIOR STRUCTURE

BEECH HARDWOOD FRAME AND WOODEN BASE

SEAT CUSHION

HR FOAM

BACK

HR FOAM

UPHOLSTERY

TIGHT

MAINTENANCE

ALL DECORATIVE CUSHIONS ARE GOOSE DOWN AND SILICON MIX, QUANTITY AND DIMENSIONS ARE AS PER TECHNICAL

We recommend shaking and fluffing-up the cushions regularly to maintain the shape. This should be done after removing the cushions from the structure for improved air circulation. For maintenance of fabric and leather, please contact your retailer.

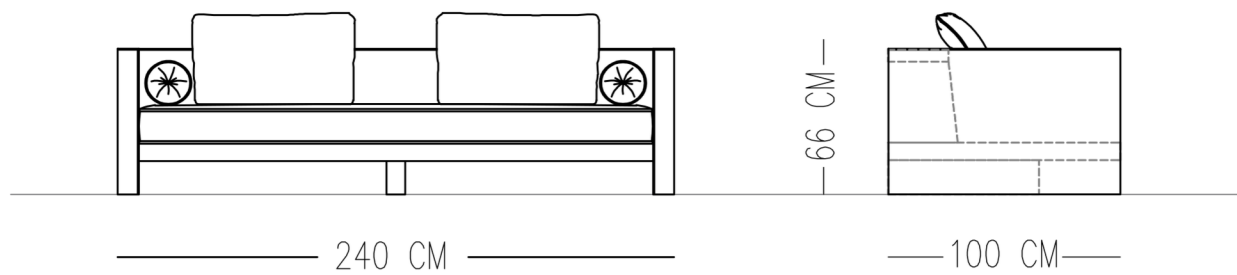

STANDARDS

SOFA - 240 CM

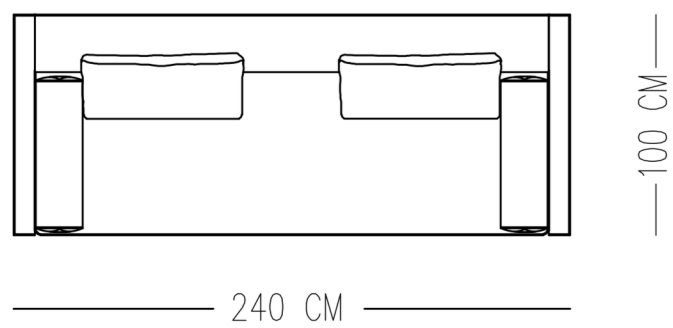

Catalog product-fabric

Vernon stonewash-1

Catalog product- Back

Lacquer painted on wood
(Matt) N-03K19

Alternative fabric

Linen, Linen teddy, Suede, Leather and
Boucle



SIXPACK SOFA

TECHNICAL SPECIFICATIONS

INTERIOR STRUCTURE

BEECH HARDWOOD FRAME AND ZIGZAG BOW

SEAT CUSHION

HR FOAM

BACK

HR FOAM

UPHOLSTERY

TIGHT

MAINTENANCE

ALL DECORATIVE CUSHIONS ARE GOOSE DOWN AND SILICON MIX. QUANTITY AND DIMENSIONS ARE AS PER TECHNICAL.

We recommend shaking and fluffing-up the cushions regularly to maintain the shape. This should be done after removing the cushions from the structure for improved air circulation. For maintenance of fabric and leather, please contact your retailer.

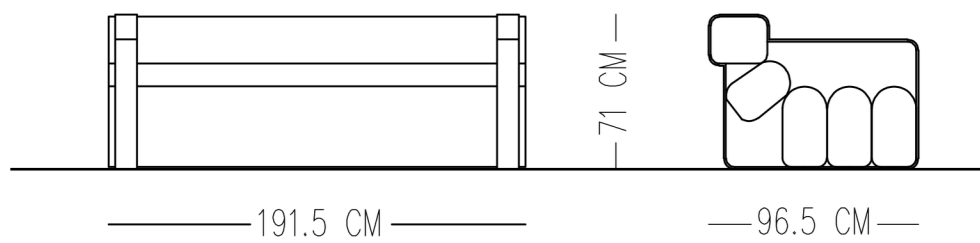

STANDARDS

SOFA - 191.5 CM

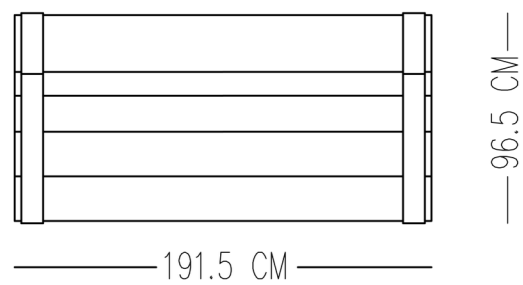

Catalog product-fabric

Barano-304

Catalog product-arm

Oak veneering with bitter
brown varnish

Alternative fabric

Linen, Linen teddy, Suede, Leather and
Boucle



ME SOFA

TECHNICAL SPECIFICATIONS

INTERIOR STRUCTURE BEECH HARDWOOD FRAME AND ZIGZAG BOW

SEAT CUSHION

HR FOAM

BACK

HR FOAM

UPHOLSTERY TIGHT

MAINTENANCE ALL DECORATIVE CUSHIONS ARE GOOSE DOWN AND SILICON MIX, QUANTITY AND DIMENSIONS ARE AS PER TECHNICAL.

We recommend shaking and fluffing-up the cushions regularly to maintain the shape. This should be done after removing the cushions from the structure for improved air circulation. For maintenance of fabric and leather, please contact your retailer.

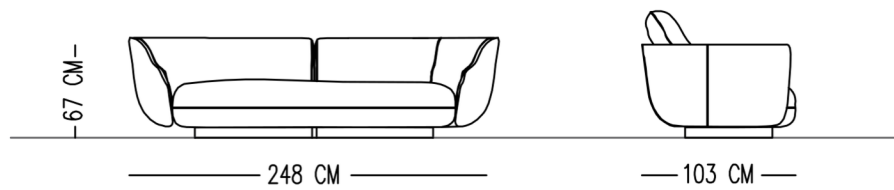

STANDARDS

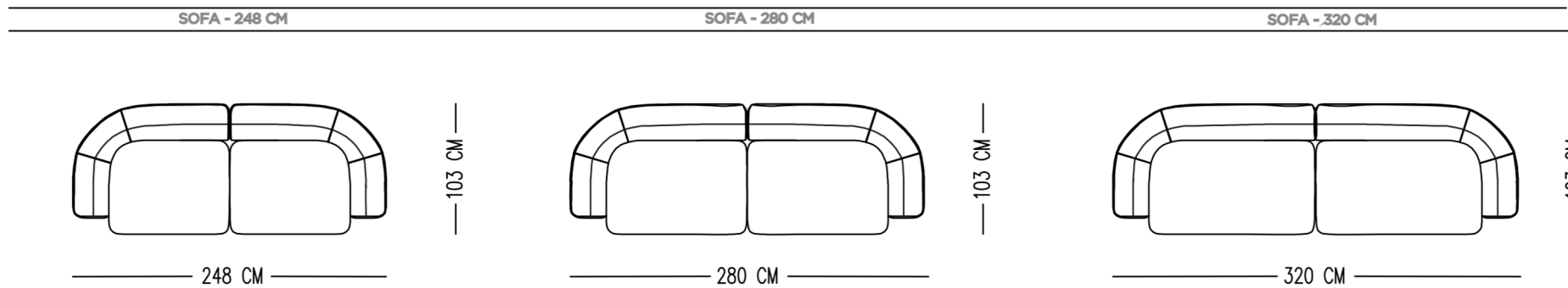

MODULES

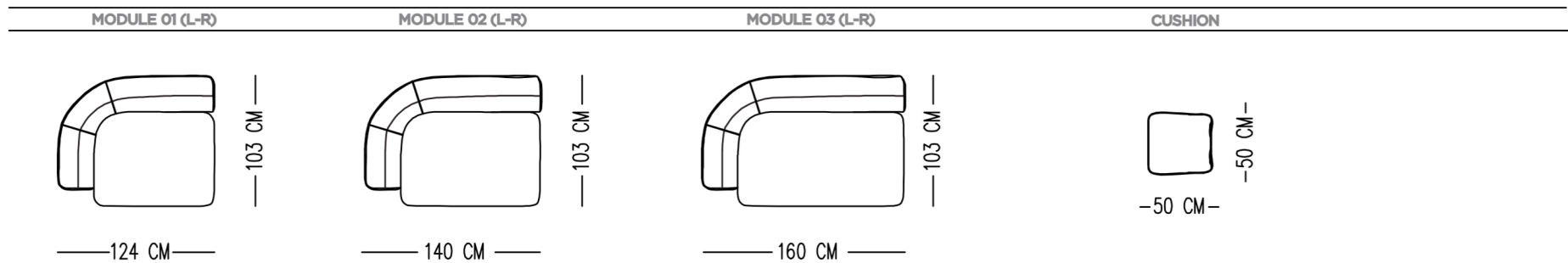

Catalog product-fabric

N-+A50/Linen
14510

Back fabric

N-+A72/Leather
Khaki

Catalog product-Legs

Laquer Painted On Wood (Matt)
N-03K19

Alternative fabric

Linen, Linen teddy, Suede, Leather and
Boucle



OLIVS SOFA

TECHNICAL SPECIFICATIONS

INTERIOR STRUCTURE BEECH HARDWOOD FRAME AND ZIGZAG BOW

SEAT CUSHION HR FOAM

BACK HR FOAM

UPHOLSTERY TIGHT

MAINTENANCE ALL DECORATIVE CUSHIONS ARE GOOSE DOWN AND SILICON MIX, QUANTITY AND DIMENSIONS ARE AS PER TECHNICAL DRAWINGS. STANDART WITH 4 CUSHIONS

We recommend shaking and fluffing-up the cushions regularly to maintain the shape. This should be done after removing the cushions from the structure for improved air circulation. For maintenance of fabric and leather, please contact your retailer.

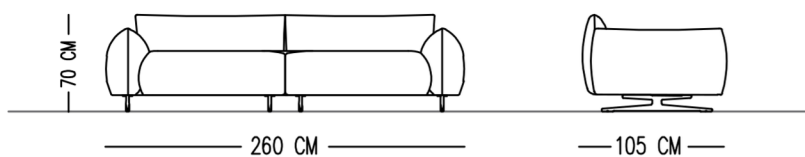

STANDARDS

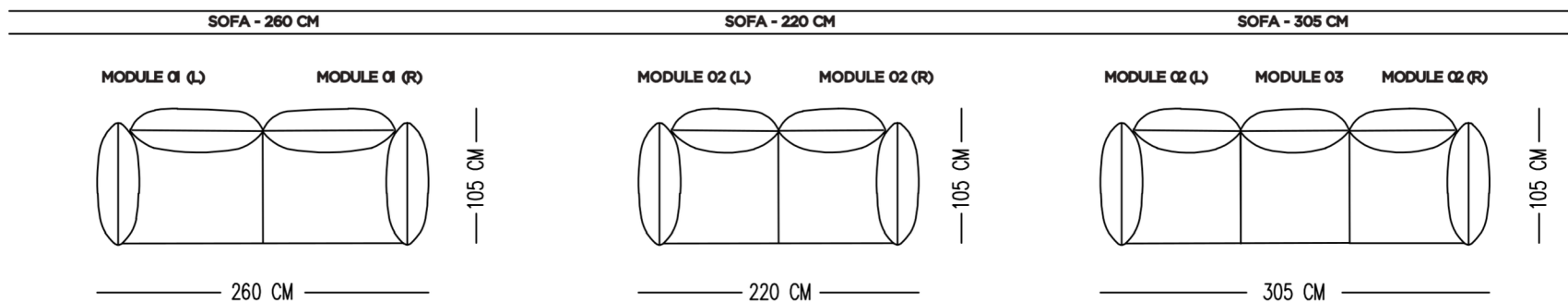

MODULES

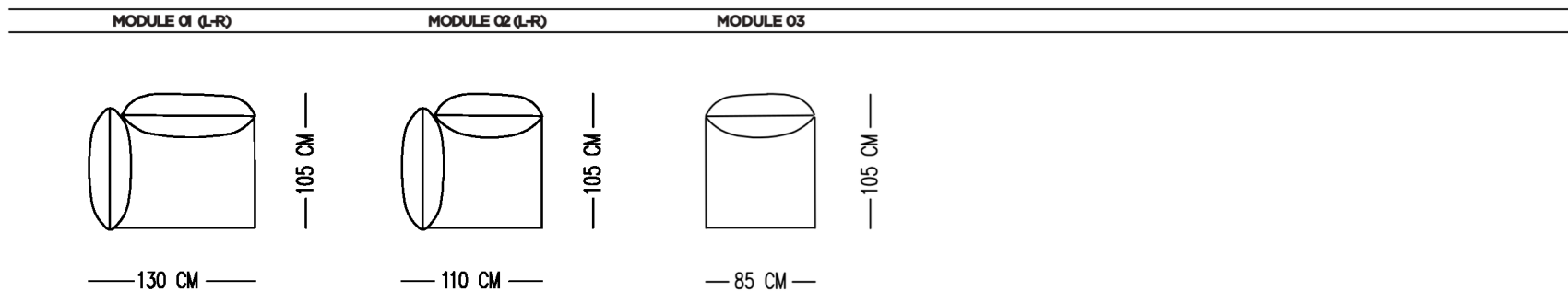

Catalog product-fabric
N-A10/Linen
40443

Catalog product-Legs
Hidden leg

Alternative fabric
Linen and Boucle



ROSA SOFA

INTERIOR STRUCTURE BEECH HARDWOOD FRAME AND ZIGZAG BOW

SEAT CUSHION HR FOAM

BACK HR FOAM

UPHOLSTERY TIGHT

MAINTENANCE ALL DECORATIVE CUSHIONS ARE GOOSE DOWN AND SILICON MIX. QUANTITY AND DIMENSIONS ARE AS PER TECHNICAL.

We recommend shaking and fluffing-up the cushions regularly to maintain the shape. This should be done after removing the cushions from the structure for improved air circulation. For maintenance of fabric and leather, please contact your retailer.

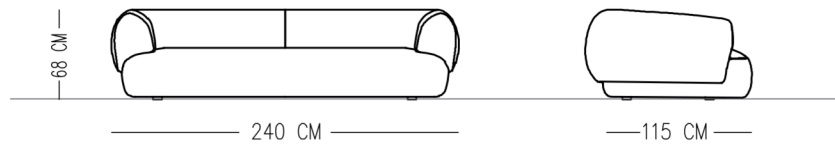

STANDARDS

SOFA - 240 CM

SOFA - 260 CM

SOFA - 280 CM

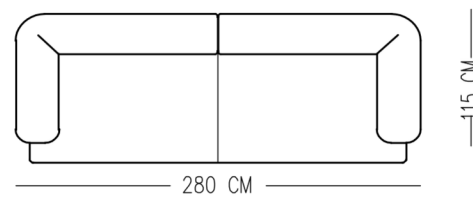
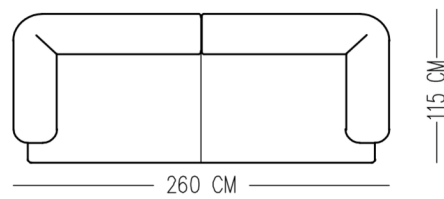
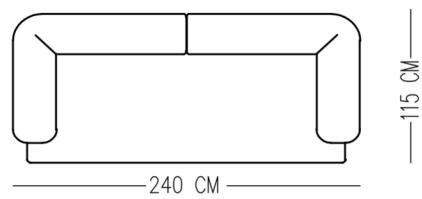

MODULES

MODULE 01 (L-R)

MODULE 02 (L-R)

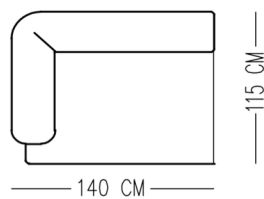
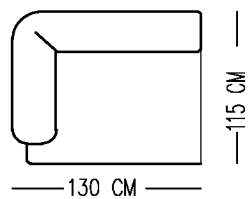

Catalog product-fabric

N-+A81/Linen
179300

Catalog product-Legs

Hidden legs



TOM SOFA

TECHNICAL SPECIFICATIONS

INTERIOR STRUCTURE

METAL STRUCTURE WITH CHROMIUM POLISH

SEAT CUSHION

COWHIDE LEATHER

UPHOLSTERY

COWHIDE LEATHER

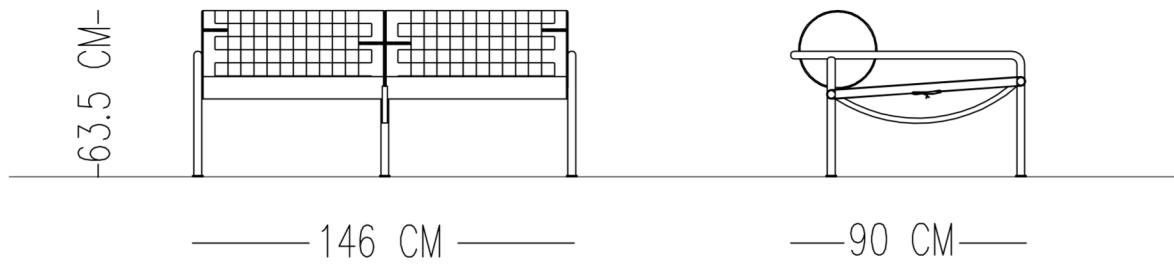

STANDARDS

SOFA - 146 CM

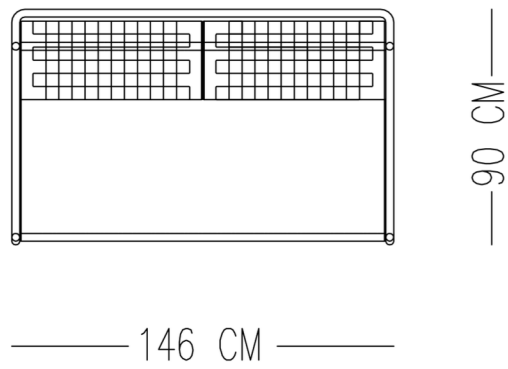

Catalog product-fabric
N-+A84/Leather
Taba

Catalog product-Legs
Chromium

Alternative fabric
Fabrics only N-+A84 are available for this model



RIVER SOFA

INTERIOR STRUCTURE BEECH HARDWOOD FRAME AND ZIGZAG BOW

SEAT CUSHION HR FOAM

BACK HR FOAM

UPHOLSTERY TIGHT

MAINTENANCE ALL DECORATIVE CUSHIONS ARE GOOSE DOWN AND SILICON MIX. QUANTITY AND DIMENSIONS ARE AS PER TECHNICAL.

We recommend shaking and fluffing-up the cushions regularly to maintain the shape. This should be done after removing the cushions from the structure for improved air circulation. For maintenance of fabric and leather, please contact your retailer.

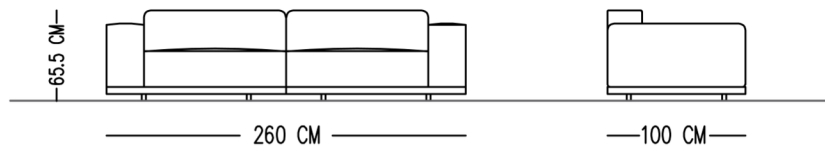

STANDARDS

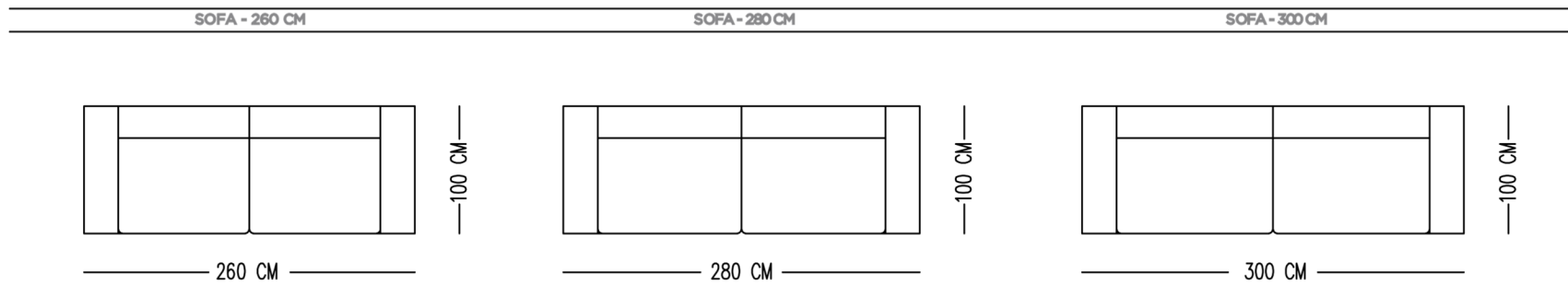

MODULES

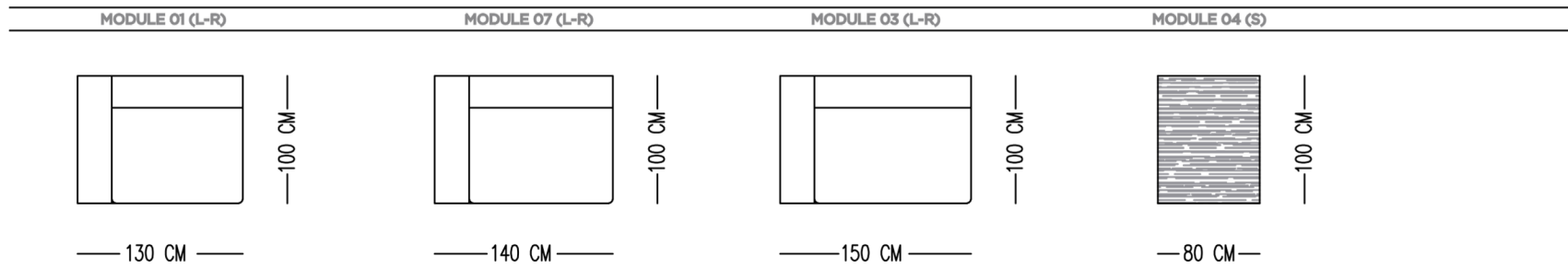

Catalog product-fabric
N+A81/Boucle
179300

Coffee Table
Oak veneering with bitter
brown varnish

Base
Leather

Catalog product-Legs
Black Leg

Alternative fabric
Linen and Boucle



VIENTOS SOFA

TECHNICAL SPECIFICATIONS

INTERIOR STRUCTURE BEECH HARDWOOD FRAME AND ZIGZAG BOW

SEAT CUSHION HR FOAM

BACK HR FOAM

UPHOLSTERY TIGHT

MAINTENANCE ALL DECORATIVE CUSHIONS ARE GOOSE DOWN AND SILICON MIX, QUANTITY AND DIMENSIONS ARE AS PER TECHNICAL DRAWINGS..STANDART WITH 4 CUSHIONS

We recommend shaking and fluffing-up the cushions regularly to maintain the shape. This should be done after removing the cushions from the structure for improved air circulation. For maintenance of fabric and leather, please contact your retailer.

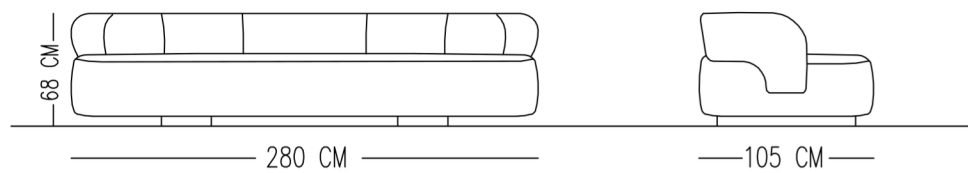

STANDARDS

SOFA - 240 CM

SOFA - 260 CM

SOFA - 280 CM

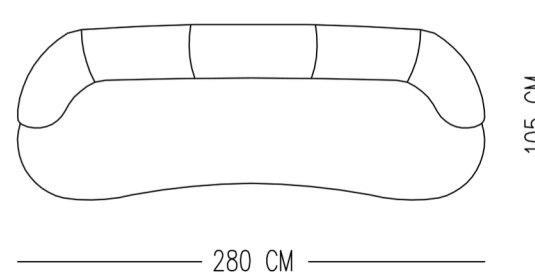
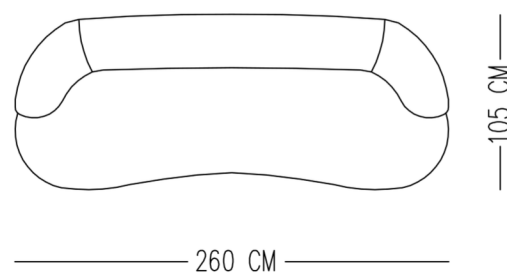
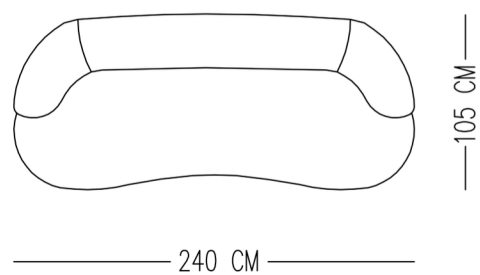

Catalog product-fabric
N-+A71/Linen boucle
2126

Catalog product-Legs
Hidden legs

Alternative fabric
Linen,Boucle, Faux leather



VIBE SOFA

TECHNICAL SPECIFICATIONS

INTERIOR STRUCTURE BEECH HARDWOOD FRAME AND ZIGZAG BOW

SEAT CUSHION HR FOAM

BACK HR FOAM

UPHOLSTERY TIGHT

MAINTENANCE ALL DECORATIVE CUSHIONS ARE GOOSE DOWN AND SILICON MIX, QUANTITY AND DIMENSIONS ARE AS PER TECHNICAL DRAWINGS. STANDART WITH 4 CUSHIONS

We recommend shaking and fluffing-up the cushions regularly to maintain the shape. This should be done after removing the cushions from the structure for improved air circulation. For maintenance of fabric and leather, please contact your retailer.

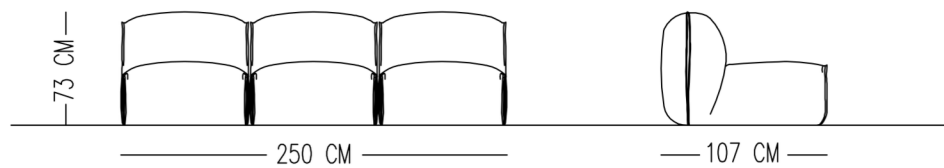

STANDARDS

SOFA - 250 CM

SOFA - 300 CM

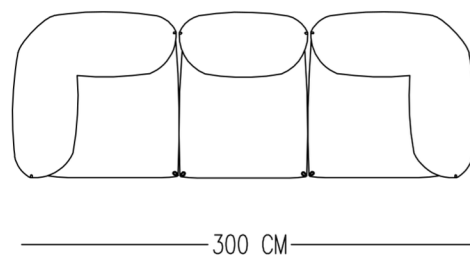
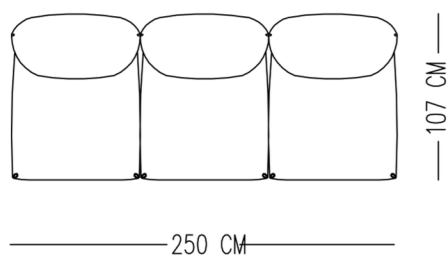

MODULES

MODULE 01

MODULE 04 (L-R)

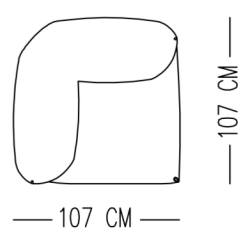
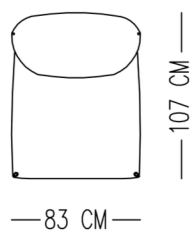

Catalog product-fabric

Catalog product-Legs

Hidden leg

N-A38/Linen
Nata

Alternative fabric
Linen, Boucle and Linen teddy



DOMINO SOFA

TECHNICAL SPECIFICATIONS

INTERIOR STRUCTURE BEECH HARDWOOD FRAME

SEAT CUSHION HR FOAM

BACK HR FOAM

UPHOLSTERY TIGHT

MAINTENANCE ALL DECORATIVE CUSHIONS ARE GOOSE DOWN AND SILICON MIX, QUANTITY AND DIMENSIONS ARE AS PER TECHNICAL.

We recommend shaking and fluffing-up the cushions regularly to maintain the shape. This should be done after removing the cushions from the structure for improved air circulation. For maintenance of fabric and leather, please contact your retailer.

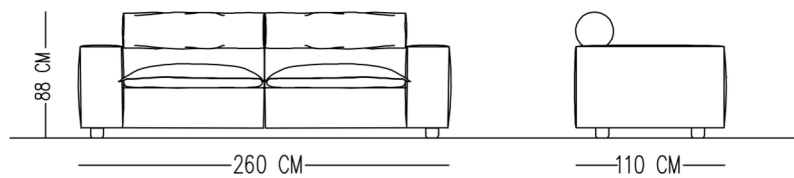

STANDARDS

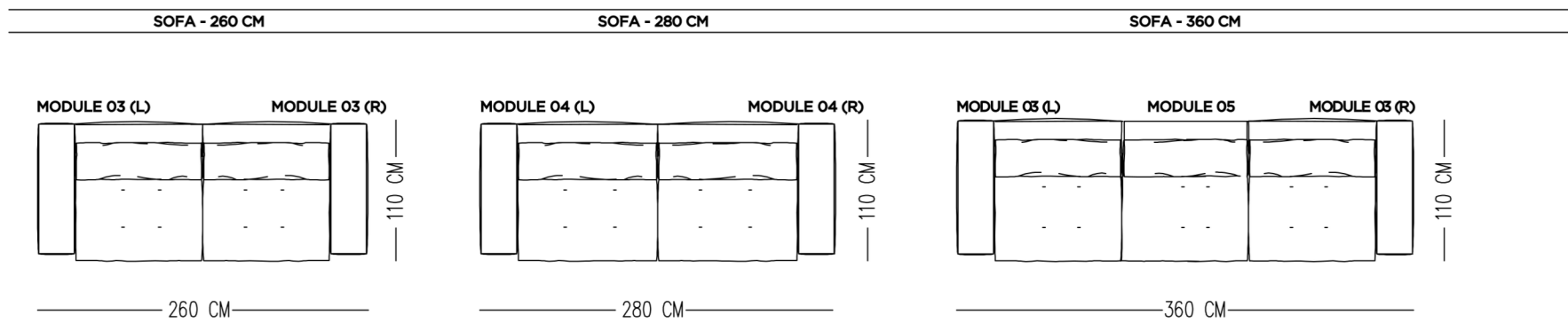

MODULES

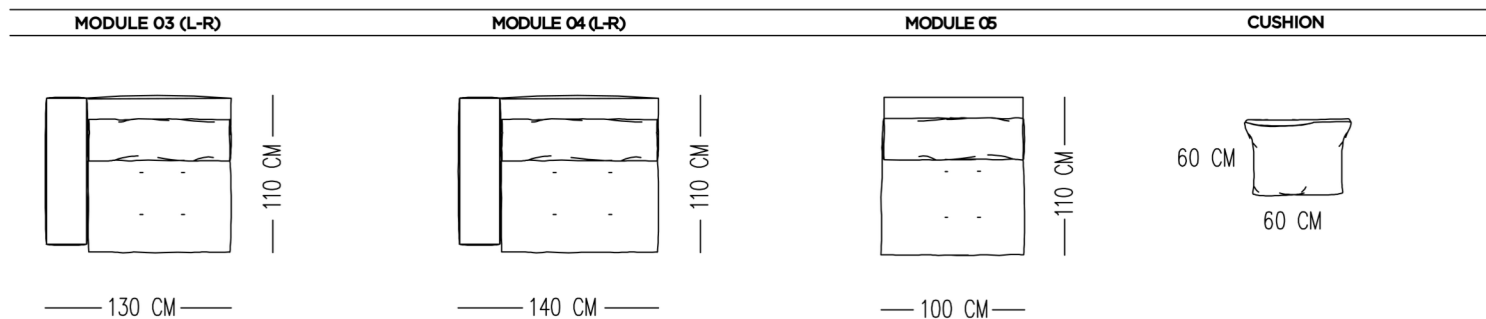

Catalog product-fabric

N-A37/Soft Velvet
15 Frost

Catalog product-Legs

Hidden leg

Alternative fabric
Linen,Soft velvet and Nubuck



BULUT SOFA

TECHNICALS PECIFICATIONS

INTERIOR STRUCTURE BEECH WOOD AND STEEL AND MDF WITH ZIGZAG BOW

STRUCTURE PADDING HR FOAM

SEAT CUSHION HR FOAM

BACK BACK CUSHION 100% DOWN/FEATHERS

UPHOLSTERY LOOSE

MAINTENANCE ALL DECORATIVE CUSHIONS ARE GOOSE DOWN AND SILICON MIX, QUANTITY AND DIMENSIONS ARE AS PER TECHNICAL DRAWINGS..STANDART WITH 2 CUSHIONS 60*60, 2 CUSHIONS 45*45,1 CUSHIONS 35*55.

We recommend shaking and fluffing-up the cushions regularly to maintain the shape.

This should be done after removing the cushions from the structure for improved air circulation.

For maintenance of fabric and leather, please contact your retailer



MARLON SOFA

TECHNICAL SPECIFICATIONS

INTERIOR STRUCTURE FRAME BEECH CONTRA, STEEL AND ZIGZAG BOW

SEAT CUSHION HR FOAM

BACK HR FOAM

UPHOLSTERY TIGHT

MAINTENANCE ALL DECORATIVE CUSHIONS ARE GOOSE DOWN AND SILICON MIX, QUANTITY AND DIMENSIONS ARE AS PER TECHNICAL DRAWINGS. STANDART WITH 2 CUSHIONS 50*50.

We recommend shaking and fluffing-up the cushions regularly to maintain the shape. This should be done after removing the cushions from the structure for improved air circulation. For maintenance of fabric and leather, please contact your retailer.

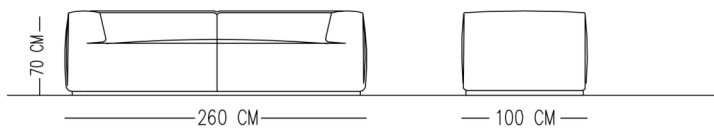

STANDARDS

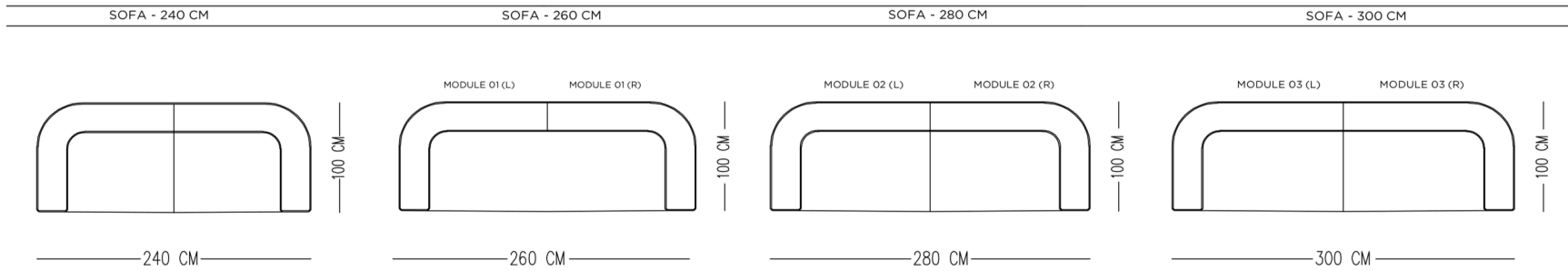

MODULES

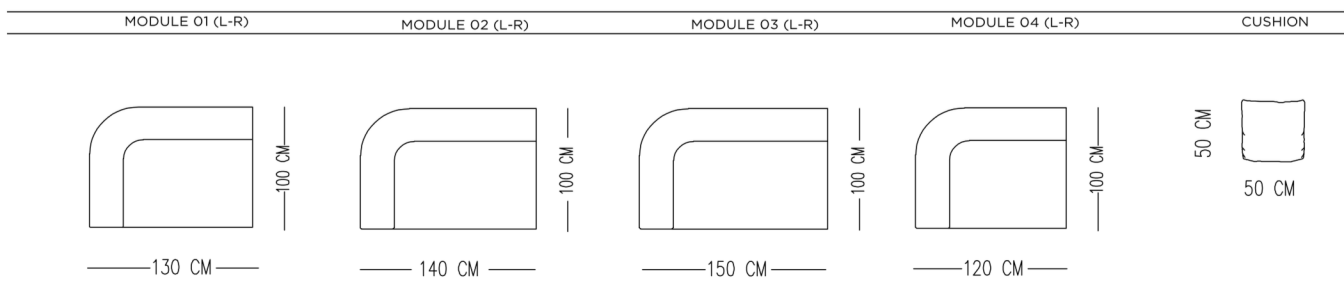

Catalog product-fabric

N-C19/Linen
21556-03

Catalog product-Legs

Hidden Wooden base and leg

Alternative fabric
Linen, Boucle and Nubuck



FRAME SOFA

TECHNICAL SPECIFICATIONS

INTERIOR STRUCTURE FRAME BEECH CONTRA, STEEL AND ZIGZAG BOW

SEAT CUSHION HR FOAM

BACK HR FOAM

UPHOLSTERY TIGHT

MAINTENANCE ALL DECORATIVE CUSHIONS ARE GOOSE DOWN AND SILICON MIX, QUANTITY AND DIMENSIONS ARE AS PER TECHNICAL DRAWINGS. STANDART WITH 2 CUSHIONS 50*50.

We recommend shaking and fluffing-up the cushions regularly to maintain the shape. This should be done after removing the cushions from the structure for improved air circulation. For maintenance of fabric and leather, please contact your retailer.

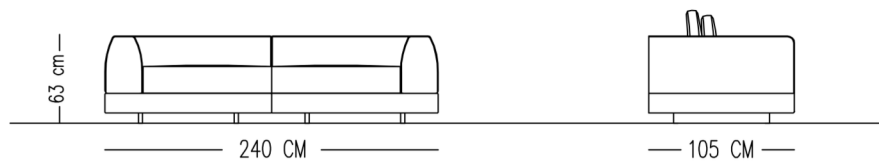

STANDARDS

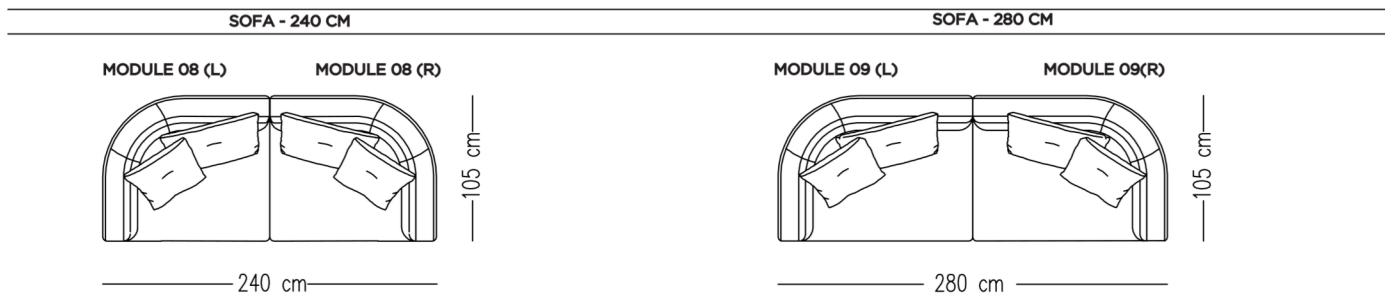
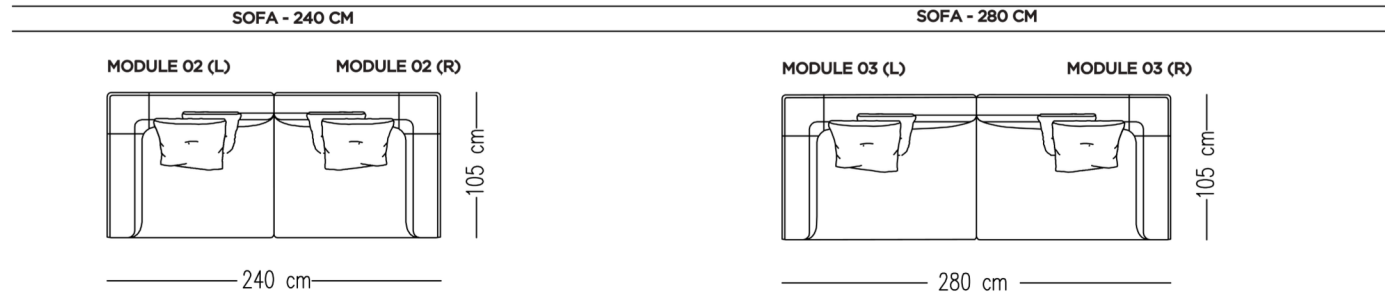

MODULES

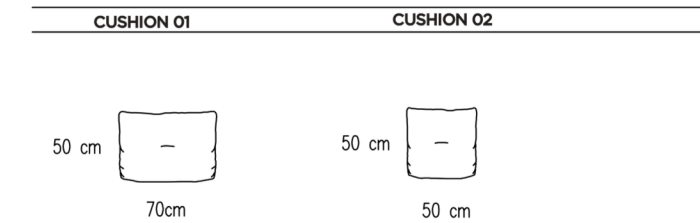
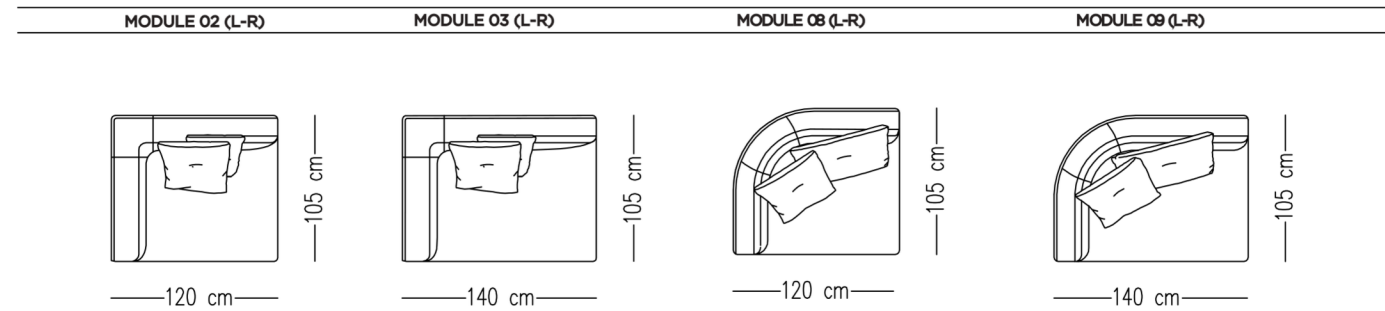

Catalog product-fabric

N-A62/Linen
4093

Catalog product-Legs

Hidden Leg

Alternative fabric
Linen, Boucle and Nubuck



ITALS SOFA

TECHNICAL SPECIFICATIONS

INTERIOR STRUCTURE BEECH HARDWOOD FRAME AND ELASTIC COLUMN

SEAT CUSHION HR FOAM

BACK HR FOAM

UPHOLSTERY TIGHT

MAINTENANCE ALL DECORATIVE CUSHIONS ARE GOOSE DOWN AND SILICON MIX, QUANTITY AND DIMENSIONS ARE AS PER TECHNICAL DRAWINGS. STANDART WITH 3 CUSHIONS 25*55. 1 CUSHIONS 45*45

We recommend shaking and fluffing-up the cushions regularly to maintain the shape. This should be done after removing the cushions from the structure for improved air circulation. For maintenance of fabric and leather, please contact your retailer.



STANDARDS

SOFA - 222 CM SOFA - 242 CM SOFA - 262 CM

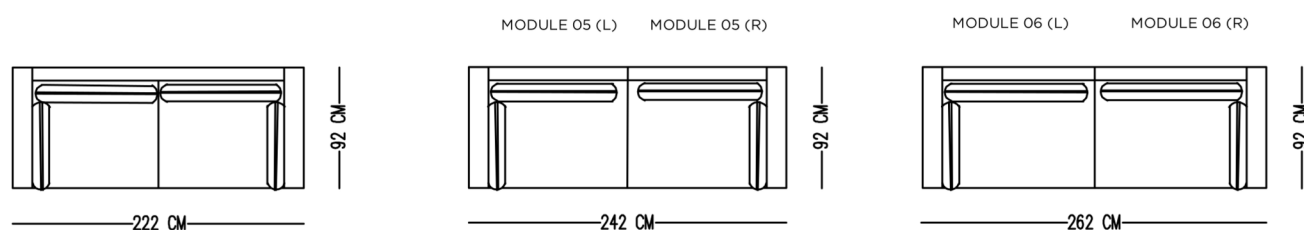

MODULES

MODULE 05 (L-R) MODULE 06 (L-R) CUSHION 01 CUSHION 02

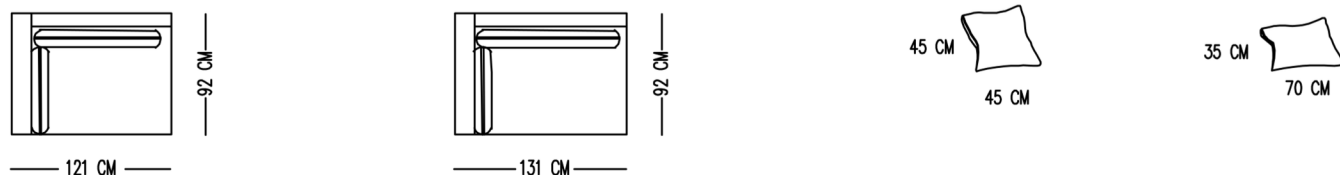

Catalog product-fabric

Tabu-0057

Catalog product-Legs

Chromium

Alternative fabric
Linen and Boucle



PORTO SOFA

TECHNICAL SPECIFICATIONS

INTERIOR STRUCTURE FRAME BEECH CONTRA AND ELASTIC COLUMN

SEAT CUSHION HR FOAM

BACK HR FOAM

UPHOLSTERY TIGHT

MAINTENANCE ALL DECORATIVE CUSHIONS ARE GOOSE DOWN AND SILICON MIX, QUANTITY AND DIMENSIONS ARE AS PER TECHNICAL DRAWINGS. STANDART WITH 4 CUSHIONS 50*50, 5 CUSHIONS 50*70

We recommend shaking and fluffing-up the cushions regularly to maintain the shape. This should be done after removing the cushions from the structure for improved air circulation. For maintenance of fabric and leather, please contact your retailer.

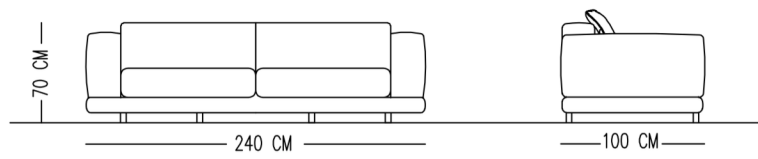

STANDARDS

SOFA - 240 CM

SOFA - 260 CM

SOFA - 280 CM

CUSHION 01

CUSHION 02

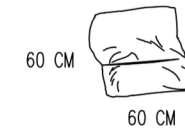
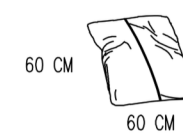
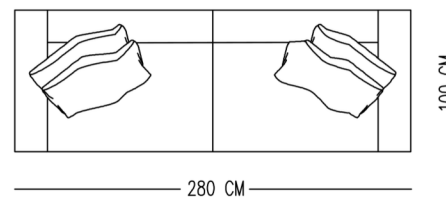
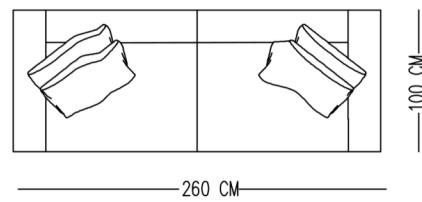
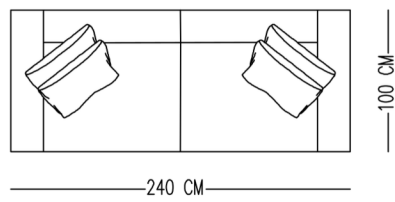

Catalog product-fabric
N-B33/Linen
09

Catalog product-Legs
Wood wenge varnish

Alternative fabric
Linen and Boucle



ANGE SOFA

TECHNICAL SPECIFICATIONS

INTERIOR STRUCTURE BEECH WOOD AND ELASTIC COLUMN

SEAT CUSHION HR FOAM

BACK HR FOAM

UPHOLSTERY TIGHT

MAINTENANCE ALL DECORATIVE CUSHIONS ARE GOOSE DOWN AND SILICON MIX. QUANTITY AND DIMENSIONS ARE AS PER TECHNICAL DRAWINGS. STANDART WITH 3 CUSHIONS 55*55, 3 CUSHIONS 45*45.

We recommend shaking and fluffing-up the cushions regularly to maintain the shape. This should be done after removing the cushions from the structure for improved air circulation. For maintenance of fabric and leather, please contact your retailer.

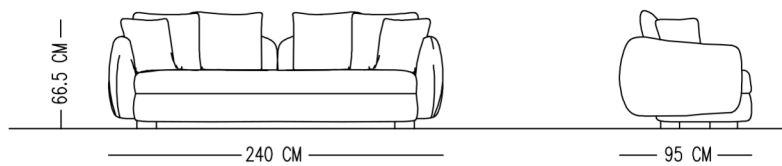

STANDARDS

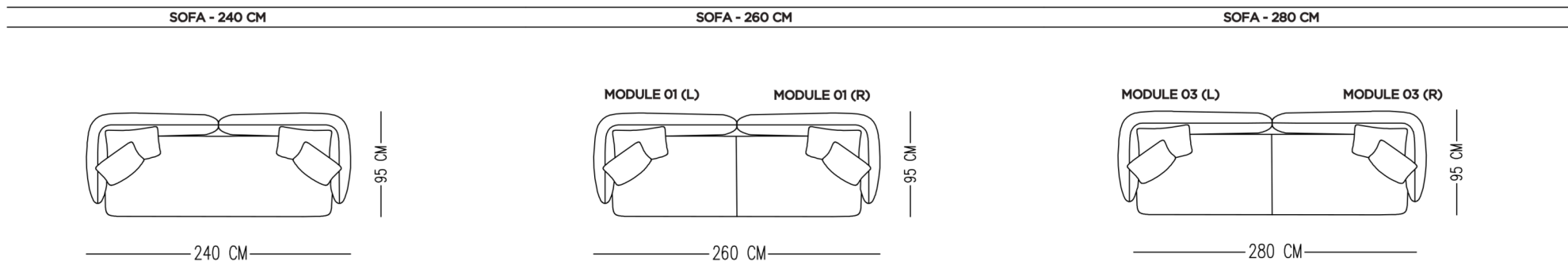

MODULES

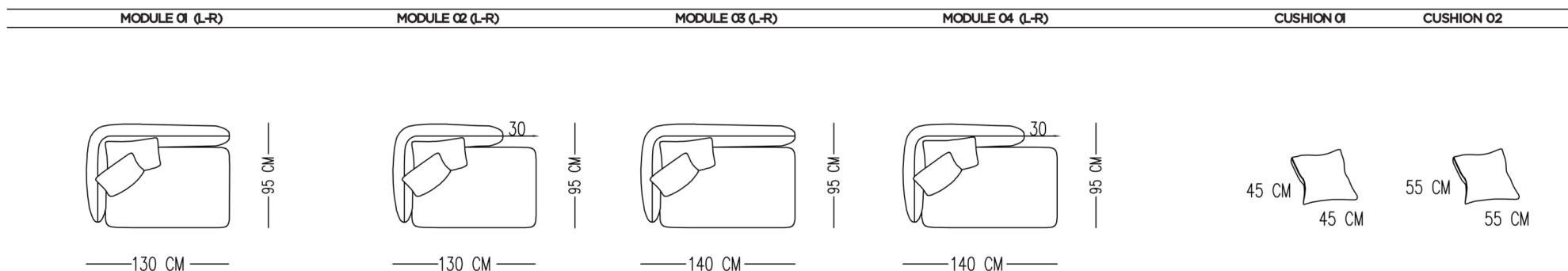

Catalog product-fabric

N-A20/Boucle
01

Catalog product-Legs

Black Painted Metal

Alternative fabric
Linen, Linen teddy, Suede and Boucle



SOMET SOFA

TECHNICAL SPECIFICATIONS

INTERIOR STRUCTURE BEECH HARDWOOD FRAME AND STEEL ZIGZAG BOW

SEAT CUSHION HR FOAM

BACK HR FOAM

UPHOLSTERY TIGHT

MAINTENANCE STANDART WITH 2 CUSHIONS

We recommend shaking and fluffing-up the cushions regularly to maintain the shape. This should be done after removing the cushions from the structure for improved air circulation. For maintenance of fabric and leather, please contact your retailer.

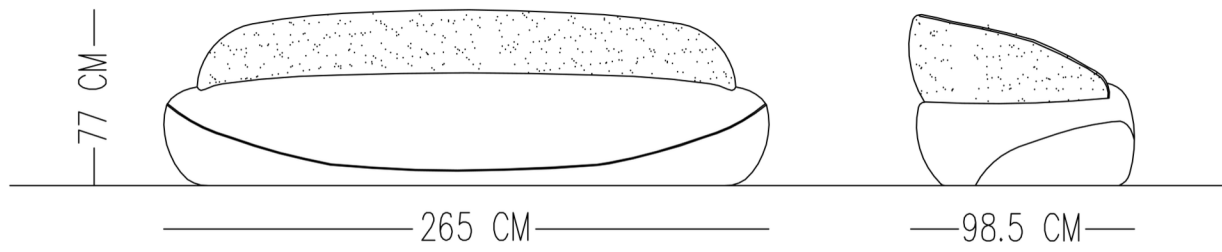

STANDARDS

SOFA - 265 CM

CUSHION

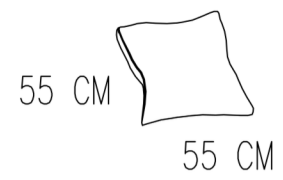
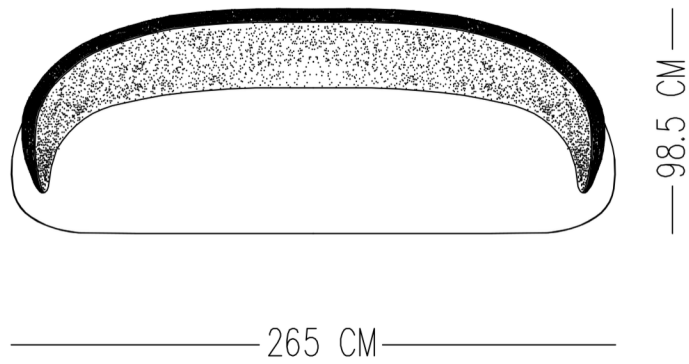

Catalog product-fabric

N-B34/Linen
08

Catalog product-Legs

Hidden Leg

Alternative fabric
Linen teddy, Boucle and Linen



AUDREY SOFA

TECHNICAL SPECIFICATIONS

INTERIOR STRUCTURE BEECH HARDWOOD FRAME AND ZIGZAG BOW

SEAT CUSHION HR FOAM

BACK HR FOAM

UPHOLSTERY TIGHT

LEGS ELECTROSTATIC POWDER BLACK PAINT ON METAL

MAINTENANCE ALL DECORATIVE CUSHIONS ARE GOOSE DOWN AND SILICON MIX, QUANTITY AND DIMENSIONS ARE AS PER TECHNICAL DRAWINGS. STANDART WITH 4 CUSHIONS

We recommend shaking and fluffing-up the cushions regularly to maintain the shape.
This should be done after removing the cushions from the structure for improved air circulation.
For maintenance of fabric and leather, please contact your retailer

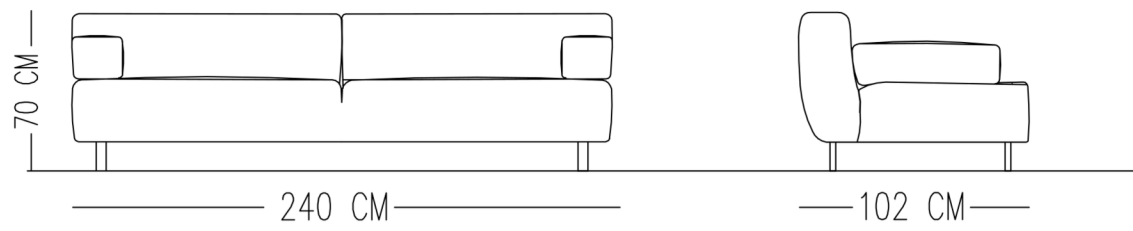

STANDARDS

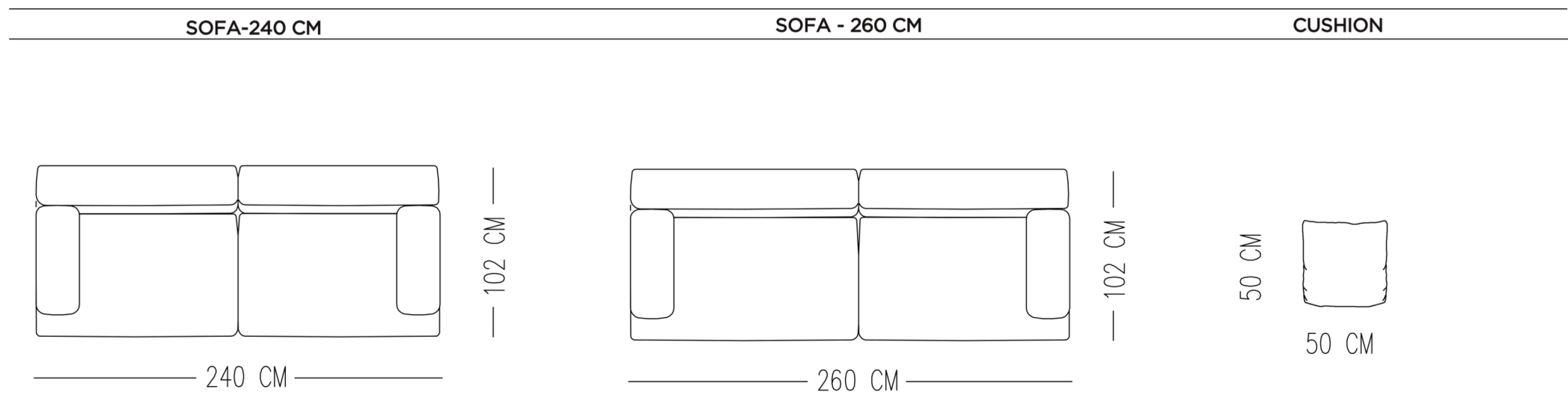

Catalog product-fabric

N-B36 /Linen Teddy
2002

Catalog product-Legs

Electrostatic Powder Black Paint On Metal

Alternative fabric
Linen,Boucle and Linen teddy



VENEDIK SOFA

TECHNICAL SPECIFICATIONS

INTERIOR STRUCTURE BEECH HARDWOOD FRAME AND ELASTIC COLUMN

SEAT CUSHION HR FOAM

BACK HR FOAM

UPHOLSTERY TIGHT

MAINTENANCE ALL DECORATIVE CUSHIONS ARE GOOSE DOWN AND SILICON MIX, QUANTITY AND DIMENSIONS ARE AS PER TECHNICAL DRAWINGS. STANDART WITH 2 CUSHIONS 45*45, 2 CUSHIONS 50*50 .

We recommend shaking and fluffing-up the cushions regularly to maintain the shape. This should be done after removing the cushions from the structure for improved air circulation. For maintenance of fabric and leather, please contact your retailer.

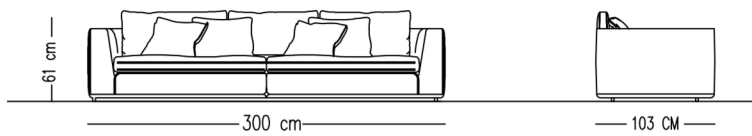

STANDARDS

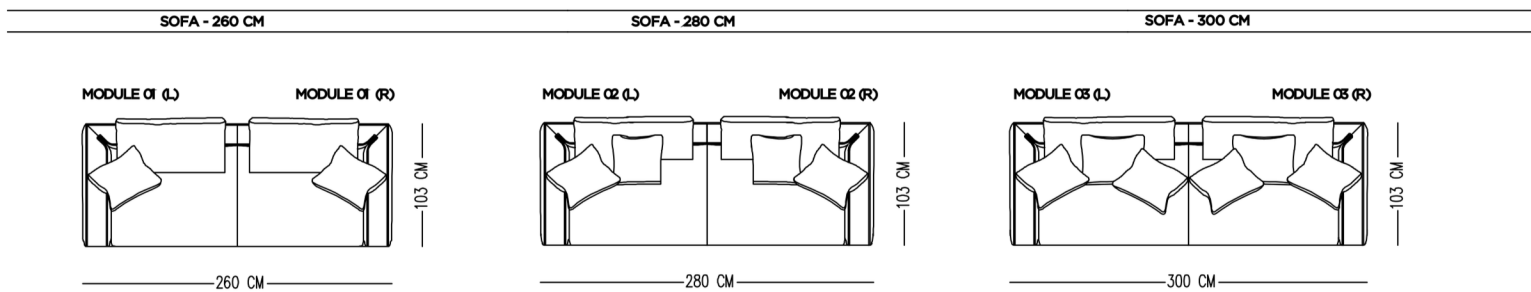

MODULES

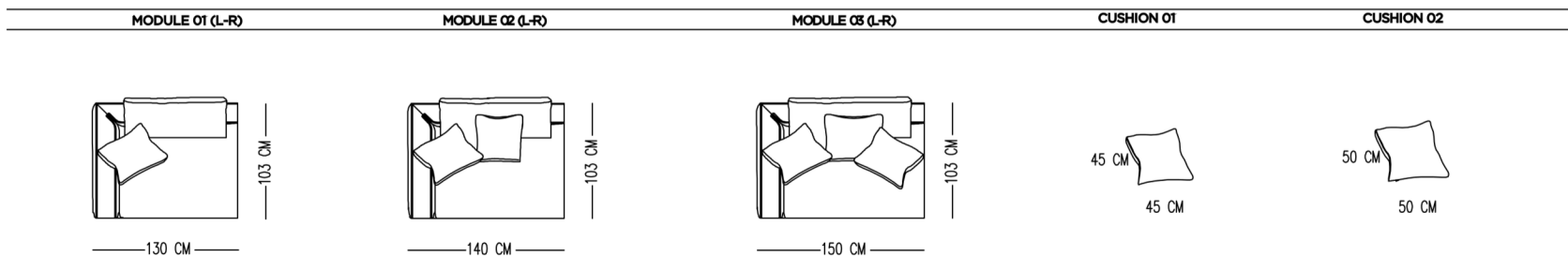

Catalog product-fabric

N-A10/Linen
43850

Catalog product-Legs

Hidden Leg

Alternative fabric
Linen,Boucle and Nubuck



BİLGİN SOFA

TECHNICAL SPECIFICATIONS

INTERIOR STRUCTURE BEECH HARDWOOD FRAME AND ELASTIC COLUMN

SEAT CUSHION HR FOAM

BACK HR FOAM

UPHOLSTERY TIGHT

MAINTENANCE ALL DECORATIVE CUSHIONS ARE GOOSE DOWN AND SILICON MIX, QUANTITY AND DIMENSIONS ARE AS PER TECHNICAL DRAWINGS. STANDART WITH 2 CUSHIONS 45*90.

We recommend shaking and fluffing-up the cushions regularly to maintain the shape. This should be done after removing the cushions from the structure for improved air circulation. For maintenance of fabric and leather, please contact your retailer.

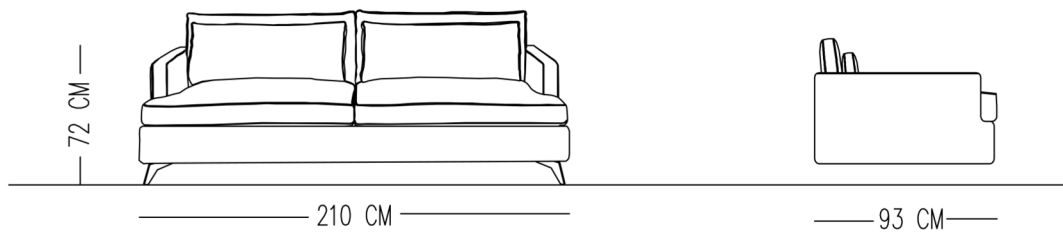

STANDARDS

SOFA - 210 CM	SOFA - 240 CM	CUSHION
---------------	---------------	---------

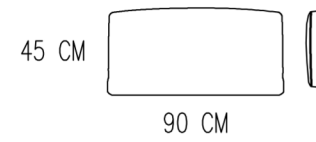
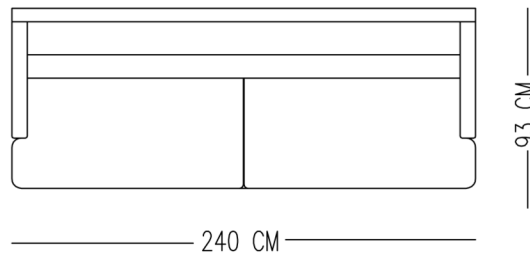
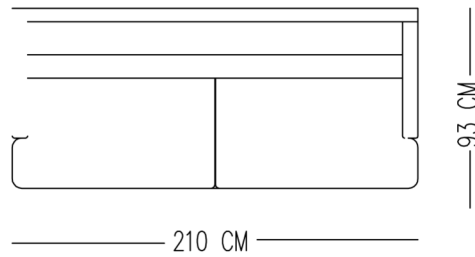

Catalog product-fabric

N-B34/Linen
08

Catalog product-Legs

Black Metal

Alternative fabric
Linen and Boucle



PIETRA SOFA

TECHNICAL SPECIFICATIONS

INTERIOR STRUCTURE FRAME BEECH AND ELASTIC COLUMN

SEAT CUSHION HR FOAM

BACK HR FOAM

UPHOLSTERY TIGHT

MAINTENANCE ALL DECORATIVE CUSHIONS ARE GOOSE DOWN AND SILICON MIX, QUANTITY AND DIMENSIONS ARE AS PER TECHNICAL DRAWINGS. STANDART WITH 4 CUSHIONS 45*45, 3 CUSHIONS 35*50

We recommend shaking and fluffing-up the cushions regularly to maintain the shape. This should be done after removing the cushions from the structure for improved air circulation. For maintenance of fabric and leather, please contact your retailer.



STANDARDS

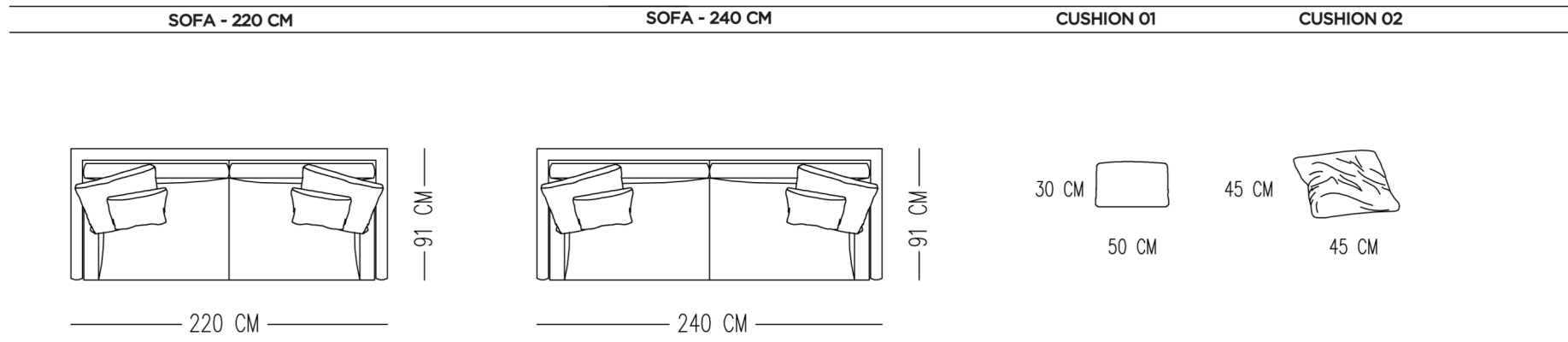

Catalog product-fabric

N-B13/Linen
A GRI - 01

Catalog product-Legs

Black wood and brass old detail

Alternative fabric
Linen and Boucle



G60 CORNER SOFA

TECHNICAL SPECIFICATIONS

INTERIOR STRUCTURE BEECH HARDWOOD FRAME AND ZIGZAG BOW

SEAT CUSHION HR FOAM

BACK HR FOAM

UPHOLSTERY TIGHT

MAINTENANCE ALL DECORATIVE CUSHIONS ARE GOOSE DOWN AND SILICON MIX, QUANTITY AND DIMENSIONS ARE AS PER TECHNICAL.

We recommend shaking and fluffing-up the cushions regularly to maintain the shape. This should be done after removing the cushions from the structure for improved air circulation. For maintenance of fabric and leather, please contact your retailer.

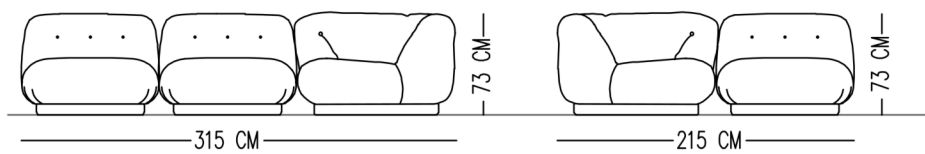

STANDARDS

CORNER SOFA - 01 (L-R)

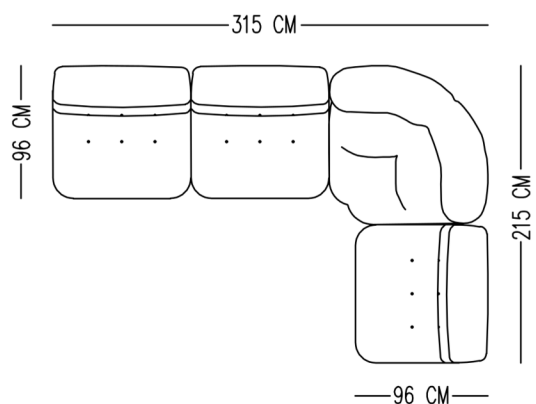

MODULES

MODULE 01

MODULE 02 (L-R)

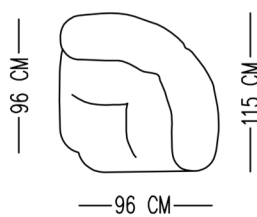
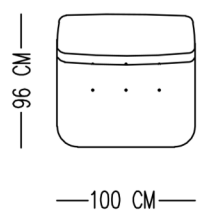

Catalog product-fabric
N-B31
9908

Catalog product-Legs
Fabric Covering

Alternative fabric
Pisa teddy fabric



LYDIA CORNER SOFA

TECHNICAL SPECIFICATIONS

INTERIOR STRUCTURE BEECH HARDWOOD FRAME AND WOODEN BASE

SEAT CUSHION HR FOAM

BACK HR FOAM

UPHOLSTERY TIGHT

MAINTENANCE ALL DECORATIVE CUSHIONS ARE GOOSE DOWN AND SILICON MIX, QUANTITY AND DIMENSIONS ARE AS PER TECHNICAL. We recommend shaking and fluffing-up the cushions regularly to maintain the shape. This should be done after removing the cushions from the structure for improved air circulation. For maintenance of fabric and leather, please contact your retailer.

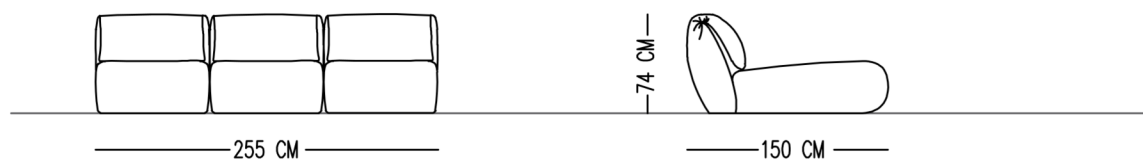

STANDARDS

CORNER SOFA - 1

CORNER SOFA - 2

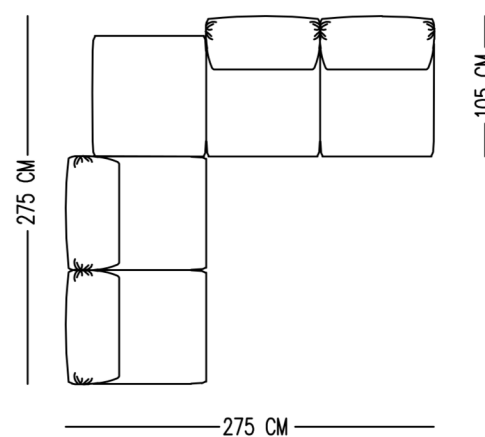
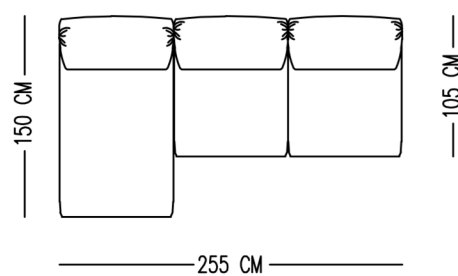

MODULES

MODULE 01

MODULE 02 (L-R)

MODULE 03

MODULE 04

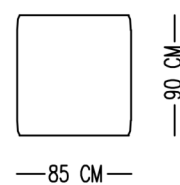
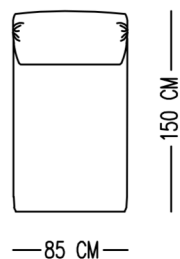
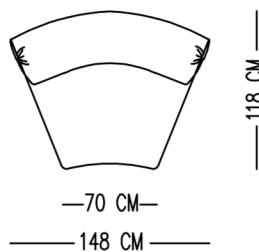
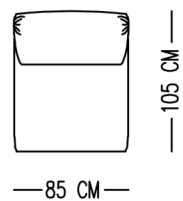

Catalog product-fabric
Enjoy me-14

Alternative fabric
Pisa teddy fabric



NIORA CORNER SOFA

TECHNICAL SPECIFICATIONS

INTERIOR STRUCTURE BEECH HARDWOOD FRAME AND WOODEN BASE

SEAT CUSHION HR FOAM

BACK HR FOAM

UPHOLSTERY TIGHT

MAINTENANCE ALL DECORATIVE CUSHIONS ARE GOOSE DOWN AND SILICON MIX, QUANTITY AND DIMENSIONS ARE AS PER TECHNICAL.
We recommend shaking and fluffing-up the cushions regularly to maintain the shape.
This should be done after removing the cushions from the structure for improved air circulation.
For maintenance of fabric and leather, please contact your retailer.

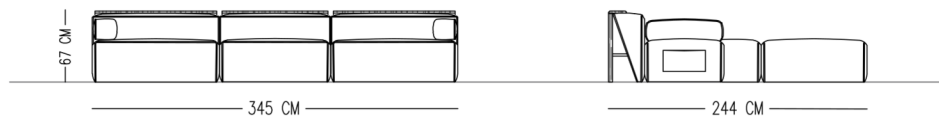

STANDARDS

CORNER SOFA - 01

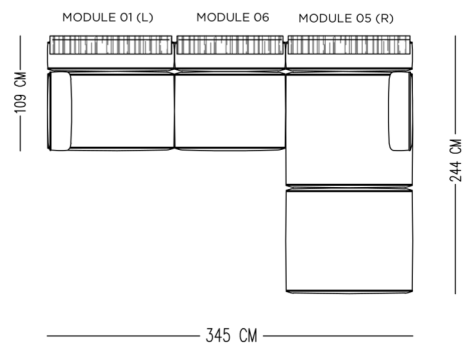

MODULES

MODULE 01 (L-R)

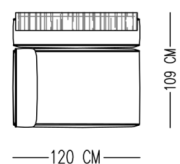

MODULE 02 (L-R)

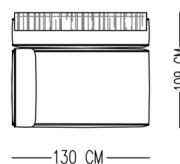

MODULE 03 (L-R)

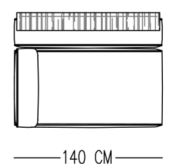

MODULE 04 (L-R)

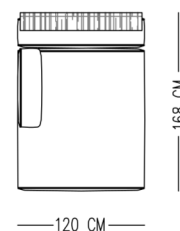

MODULE 05 (L-R)

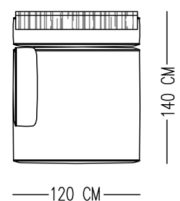

MODULE 06

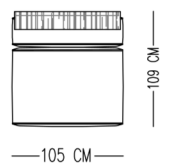

MODULE 07 (L-R)

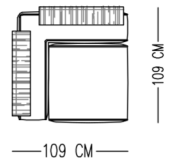

MODULE 08 (L-R)

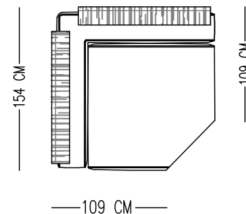

MODULE 09

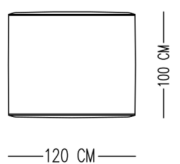

Catalog product-fabric
Kinali-7

Catalog product-back
N-02HP paint finish on oak
wood Veneering (Matt)

Catalog product-Legs
Hidden Leg

Alternative fabric
Pisa teddy fabric



TOPRAK CORNER SOFA

TECHNICAL SPECIFICATIONS

INTERIOR STRUCTURE BEECH HARDWOOD FRAME

SEAT CUSHION HR FOAM

ARMREST PLEXY

UPHOLSTERY TIGHT

MAINTENANCE ALL DECORATIVE CUSHIONS ARE GOOSE DOWN AND SILICON MIX, QUANTITY AND DIMENSIONS ARE AS PER TECHNICAL.
We recommend shaking and fluffing-up the cushions regularly to maintain the shape.
This should be done after removing the cushions from the structure for improved air circulation.
For maintenance of fabric and leather, please contact your retailer.

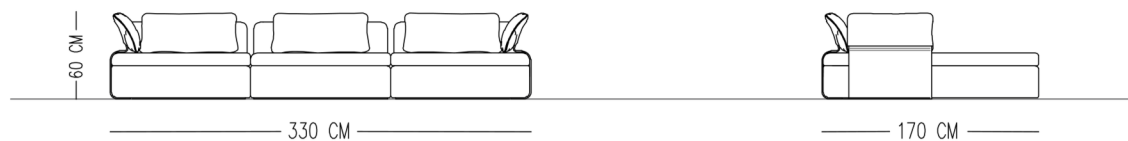

STANDARDS

CORNER SOFA - 01

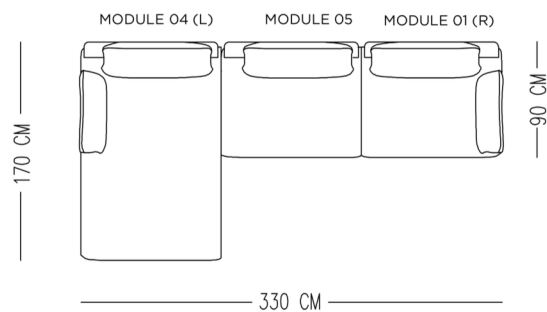

MODULES

MODULE 01 (L-R)

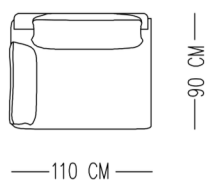

MODULE 02 (L-R)

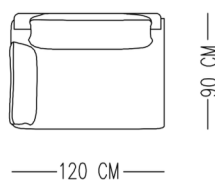

MODULE 03 (L-R)

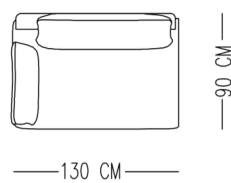

MODULE 04 (L-R)

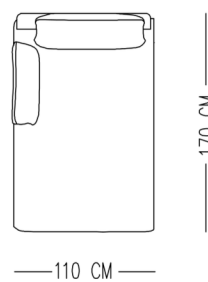

MODULE 05

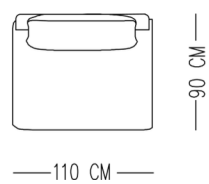

MODULE 06

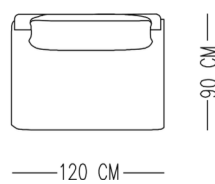

MODULE 07

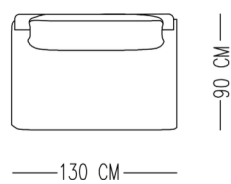

Catalog product-fabric
Omerta-4282

Catalog product-arm
Bronze plexy

Alternative fabric
Pisa teddy fabric



ME CORNER SOFA

TECHNICAL SPECIFICATIONS

INTERIOR STRUCTURE BEECH HARDWOOD FRAME AND ZIGZAG BOW

SEAT CUSHION

HR FOAM

BACK

HR FOAM

UPHOLSTERY TIGHT

MAINTENANCE ALL DECORATIVE CUSHIONS ARE GOOSE DOWN AND SILICON MIX, QUANTITY AND DIMENSIONS ARE AS PER TECHNICAL.

We recommend shaking and fluffing-up the cushions regularly to maintain the shape. This should be done after removing the cushions from the structure for improved air circulation. For maintenance of fabric and leather, please contact your retailer.

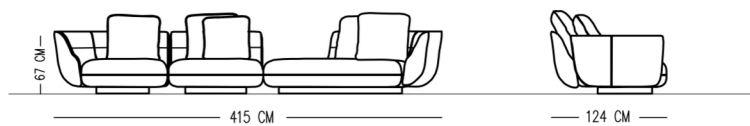

STANDARDS

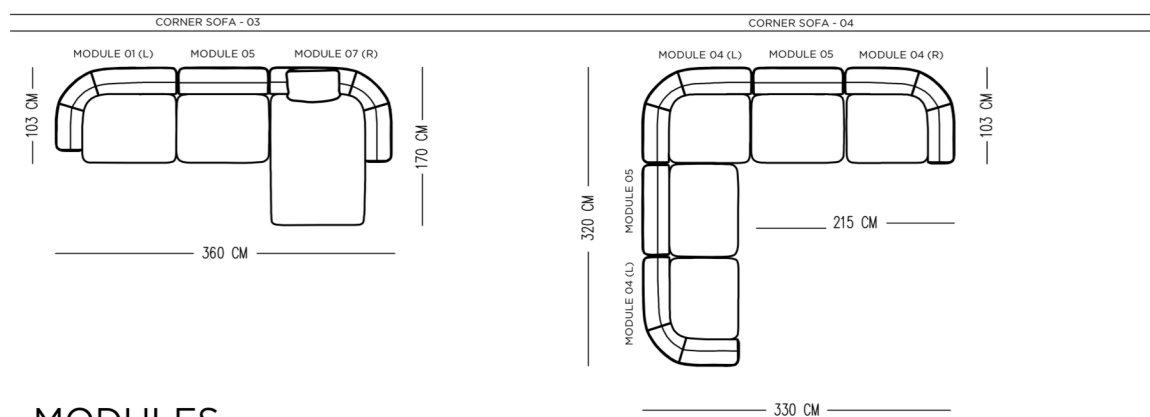
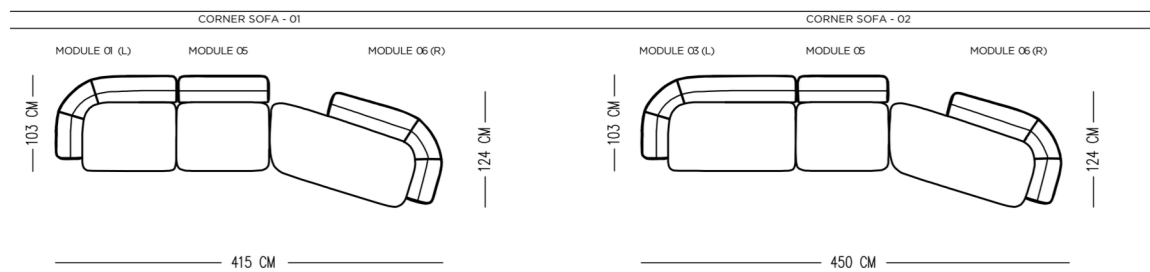

MODULES

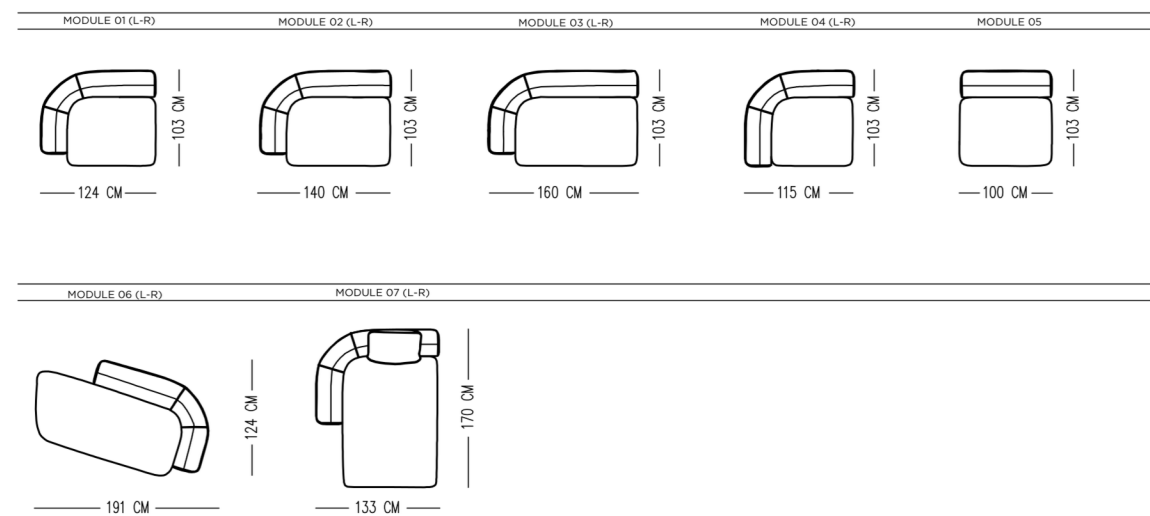

Catalog product-fabric

N-+A50/Linen
14510

Back fabric
N-+A72/Leather
Khaki

Catalog product-Legs
Laquer Painted On Wood (Matt)
N-03K19

Alternative fabric
Linen,Linen teddy,Suede, Leather and
Boucle



RIVER CORNER SOFA

INTERIOR STRUCTURE BEECH HARDWOOD FRAME AND ZIGZAG BOW

SEAT CUSHION HR FOAM

BACK HR FOAM

UPHOLSTERY TIGHT

MAINTENANCE ALL DECORATIVE CUSHIONS ARE GOOSE DOWN AND SILICON MIX. QUANTITY AND DIMENSIONS ARE AS PER TECHNICAL.

We recommend shaking and fluffing-up the cushions regularly to maintain the shape. This should be done after removing the cushions from the structure for improved air circulation. For maintenance of fabric and leather, please contact your retailer.

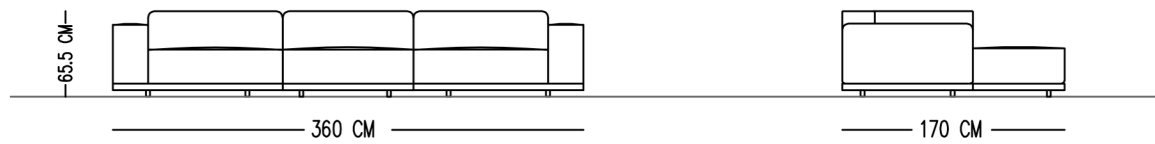

STANDARDS

CORNER SOFA - 01

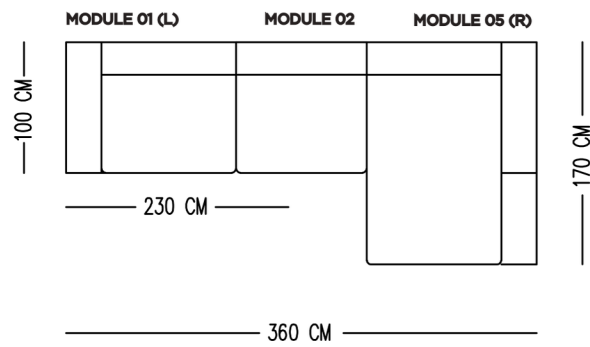

MODULES

MODULE 01 (L-R)

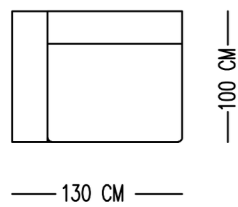

MODULE 02

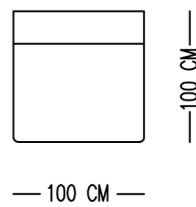

MODULE 03 (L-R)

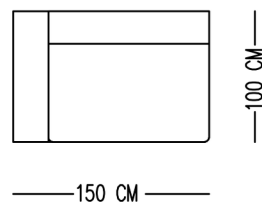

MODULE 04 (S)

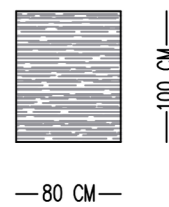

MODULE 05 (L-R)

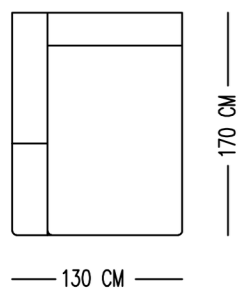

CORNER - MODULE 06 (L-R)

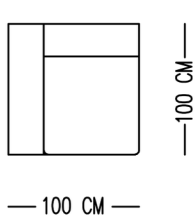

MODULE 07 (L-R)

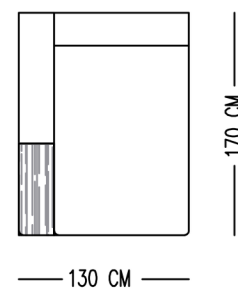

Catalog product-fabric
N-A10/Linen
40443

Coffee Table
Oak veneering with bitter
brown varnish

Base
Leather

Catalog product-Legs
Black Leg

Alternative fabric
Linen and Boucle



ROSA CORNER SOFA

INTERIOR STRUCTURE BEECH HARDWOOD FRAME AND ZIGZAG BOW

SEAT CUSHION HR FOAM

BACK HR FOAM

UPHOLSTERY TIGHT

MAINTENANCE ALL DECORATIVE CUSHIONS ARE GOOSE DOWN AND SILICON MIX. QUANTITY AND DIMENSIONS ARE AS PER TECHNICAL.

We recommend shaking and fluffing-up the cushions regularly to maintain the shape. This should be done after removing the cushions from the structure for improved air circulation. For maintenance of fabric and leather, please contact your retailer.

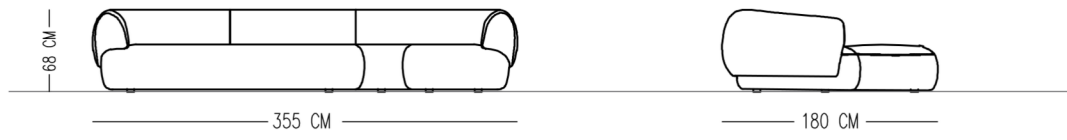

STANDARDS

CORNER SOFA - 01

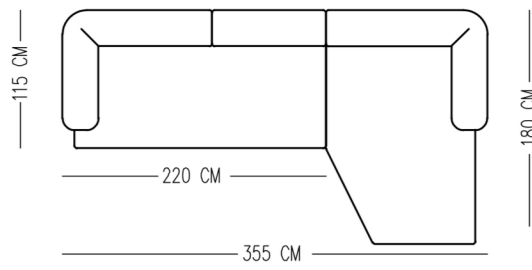

MODULES

MODULE 03 (L-R)

MODULE 04 (L-R)

MODULE 05 (L-R)

MODULE 06 (L-R)

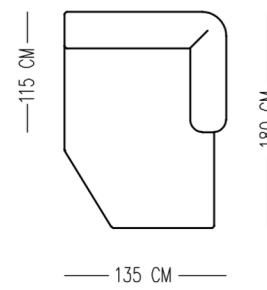
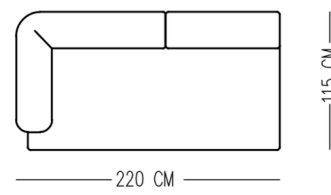
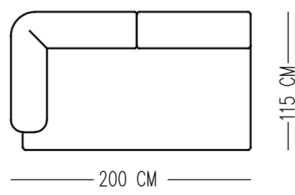
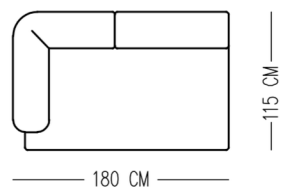

Catalog product-fabric
N-+A81/Linen
179300

Catalog product-Legs
Hidden leg



AUDREY CORNER SOFA

TECHNICAL SPECIFICATIONS

INTERIOR STRUCTURE BEECH HARDWOOD FRAME AND ZIGZAG BO W

SEAT CUSHION HR FOAM

BACK HR FOAM

UPHOLSTERY TIGHT

LEGS ELECTROSTATIC POWDER BLACK PAINT ON METAL

MAINTENANCE ALL DECORATIVE CUSHIONS ARE GOOSE DOWN AND SILICON MIX. QUANTITY AND DIMENSIONS ARE AS PER TECHNICAL DRAWINGS..STANDART WITH 4 CUSHIONS

We recommend shaking and fluffing-up the cushions regularly to maintain the shape.
This should be done after removing the cushions from the structure for improved air circulation.
For maintenance of fabric and leather, please contact your retailer

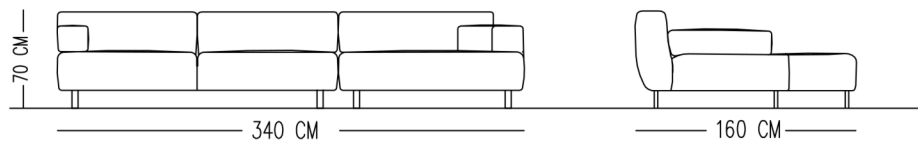

STANDARDS

CORNER SOFA - 340 CM

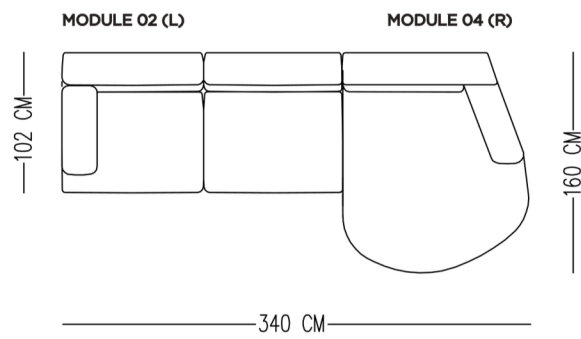

MODULES

MODULE 01 (L-R)

MODULE 02 (L-R)

MODULE 03 (L-R)

MODULE 04 (L-R)

CUSHION

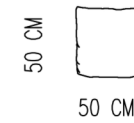
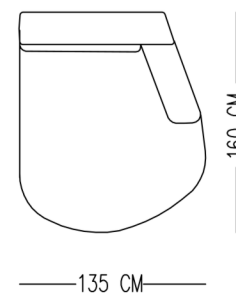
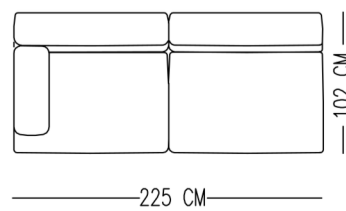
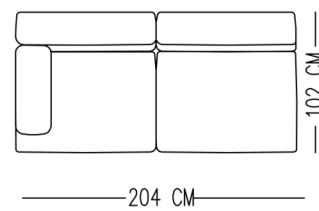
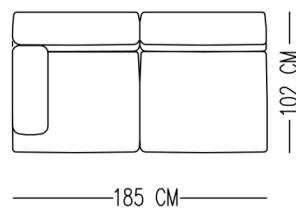

Catalog product-fabric
N-A57/Linen Velvet
5048

Catalog product-Legs
Electrostatic Powder
Black Paint On Metal

Alternative fabric
Linen, Boucle and Linen teddy



DOMINO CORNER SOFA

TECHNICAL SPECIFICATIONS

INTERIOR STRUCTURE BEECH HARDWOOD FRAME

SEAT CUSHION HR FOAM

BACK HR FOAM

UPHOLSTERY TIGHT

MAINTENANCE ALL DECORATIVE CUSHIONS ARE GOOSE DOWN AND SILICON MIX, QUANTITY AND DIMENSIONS ARE AS PER TECHNICAL.

We recommend shaking and fluffing-up the cushions regularly to maintain the shape. This should be done after removing the cushions from the structure for improved air circulation. For maintenance of fabric and leather, please contact your retailer.

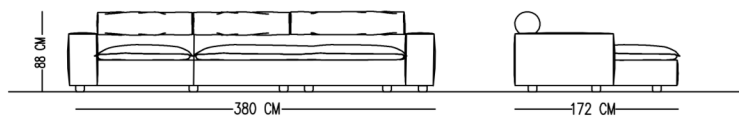

STANDARDS

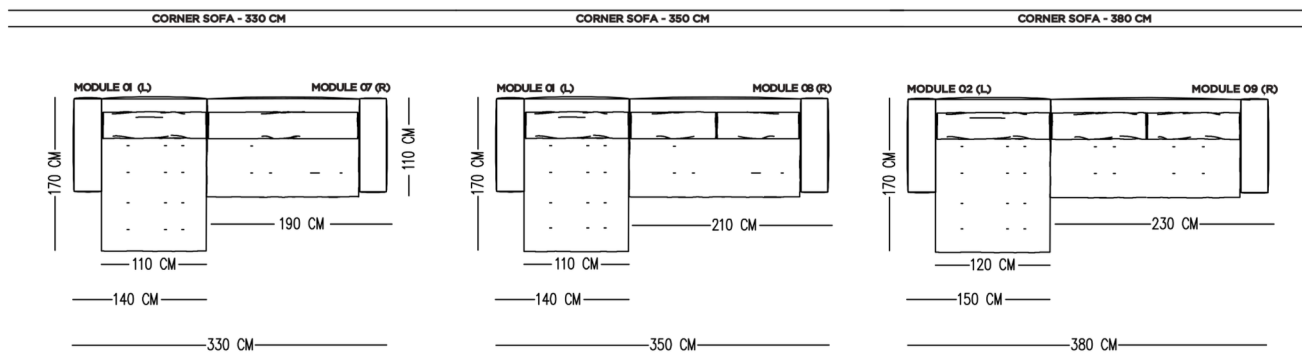

MODULES

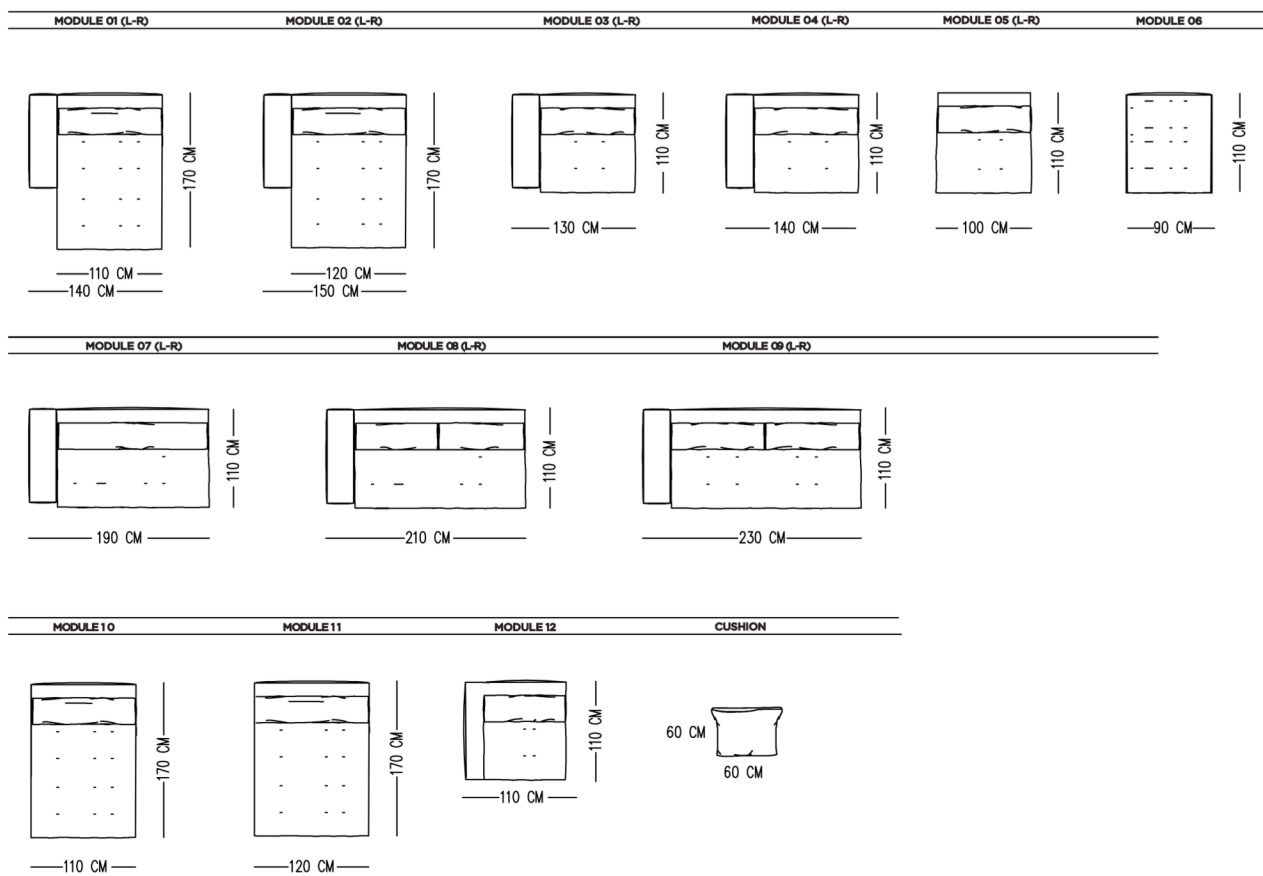

Catalog product-fabric

N-A17/Nubuck
048

Catalog product-Legs

Hidden Leg

Alternative fabric
Linen,Soft velvet and Nubuck



BULUT CORNER SOFA

TECHNICALS PECIFICATIONS

INTERIOR STRUCTURE BEECH WOOD AND STEEL AND MDF WITH ZIGZAG BOW

STRUCTURE PADDING HR FOAM

SEAT CUSHION HR FOAM

BACK BACK CUSHION 100% DOWN/FEATHERS

UPHOLSTERY LOOSE

MAINTENANCE ALL DECORATIVE CUSHIONS ARE GOOSE DOWN AND SILICON MIX, QUANTITY AND DIMENSIONS ARE AS PER TECHNICAL DRAWINGS. STANDART WITH 2 CUSHIONS 60*60, 2 CUSHIONS 45*45, 1 CUSHIONS 35*55.

We recommend shaking and fluffing-up the cushions regularly to maintain the shape.

This should be done after removing the cushions from the structure for improved air circulation.

For maintenance of fabric and leather, please contact your retailer

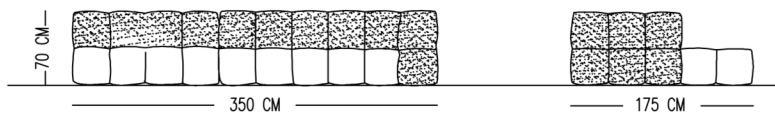

STANDARDS

CORNER SOFA - 350 CM

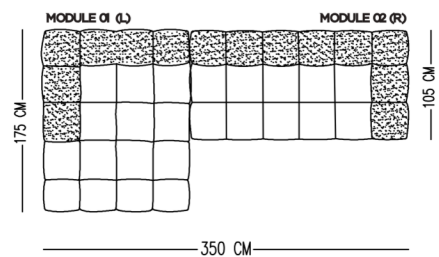

MODULES

MODULE 01 (L-R)

MODULE 02 (L-R)

MODULE 03 (L-R)

MODULE 04 (L-R)

MODULE 05 (L-R)

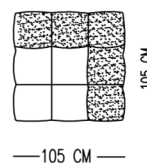
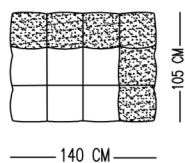
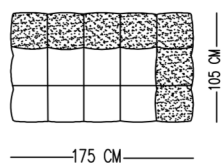
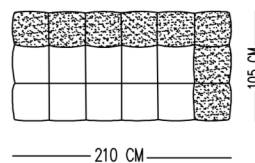
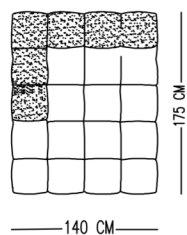

MODULE 08 (L-R)

MODULE 06

MODULE 07 (P)

CUSHION 01

CUSHION 02

CUSHION 03

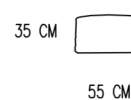
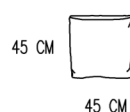
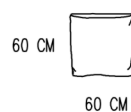
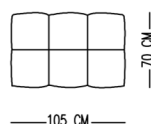
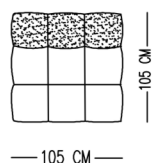
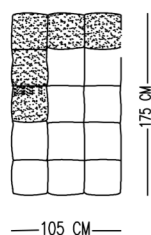

Catalog product-fabric

Catalog product-Legs

N-A16/Teddy
46860

Hidden Leg

Alternative fabric
Linen teddy, Suede, Linen and Boucle



VIBE CORNER SOFA

TECHNICAL SPECIFICATIONS

INTERIOR STRUCTURE BEECH HARDWOOD FRAME AND ZIGZAG BOW

SEAT CUSHION HR FOAM

BACK HR FOAM

UPHOLSTERY TIGHT

MAINTENANCE ALL DECORATIVE CUSHIONS ARE GOOSE DOWN AND SILICON MIX, QUANTITY AND DIMENSIONS ARE AS PER TECHNICAL DRAWINGS. STANDART WITH 4 CUSHIONS

We recommend shaking and fluffing-up the cushions regularly to maintain the shape. This should be done after removing the cushions from the structure for improved air circulation. For maintenance of fabric and leather, please contact your retailer.



STANDARDS

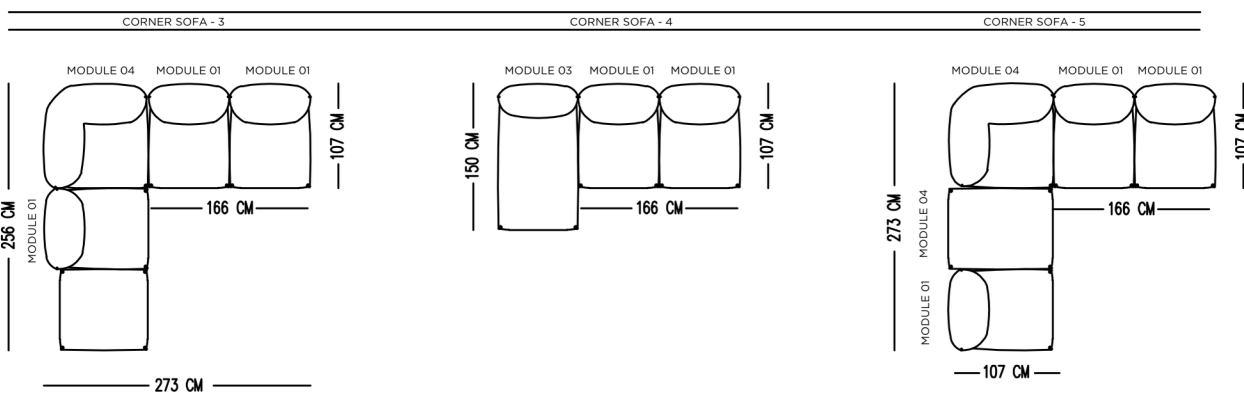
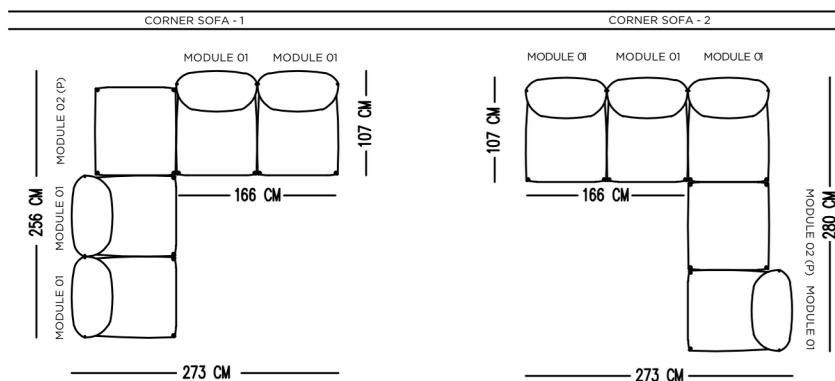

MODULES

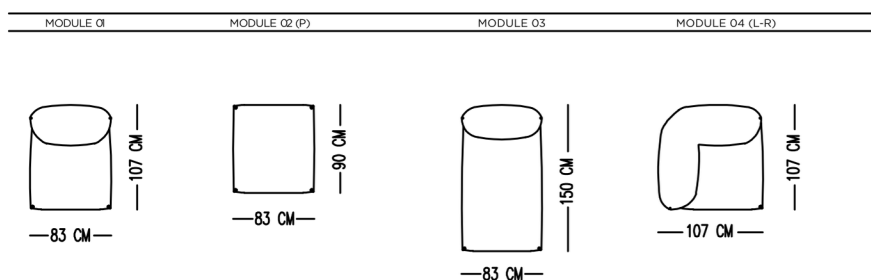

Catalog product-fabric

N-+A47/ Boucle
14500

Catalog product-Legs

Hidden leg

Alternative fabric
Linen, Boucle and Linen teddy



FRAME CORNER SOFA

TECHNICAL SPECIFICATIONS

INTERIOR STRUCTURE BEECH HARDWOOD FRAME AND ZIGZAG BOW

SEAT CUSHION HR FOAM

BACK HR FOAM

UPHOLSTERY TIGHT

MAINTENANCE ALL DECORATIVE CUSHIONS ARE GOOSE DOWN AND SILICON MIX, QUANTITY AND DIMENSIONS ARE AS PER TECHNICAL DRAWINGS. STANDART WITH 6 CUSHIONS 55*55.

We recommend shaking and fluffing-up the cushions regularly to maintain the shape. This should be done after removing the cushions from the structure for improved air circulation. For maintenance of fabric and leather, please contact your retailer.



STANDARDS

CORNER SOFA - 1

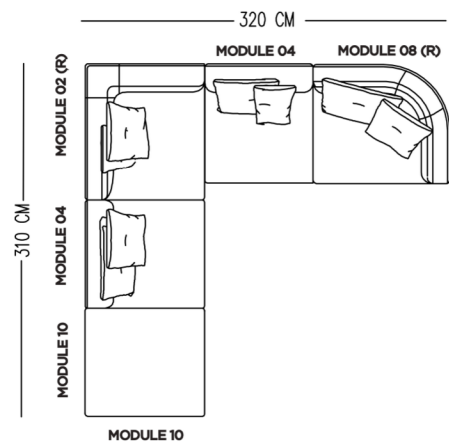

MODULE 01 (L-R)

MODULE 02 (L-R)

MODULE 03 (L-R)

MODULE 04

MODULE 05

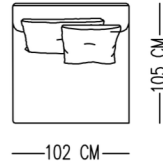
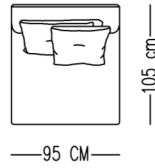
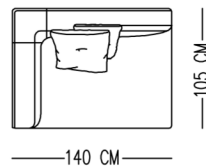
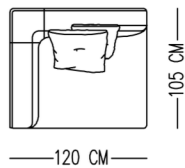
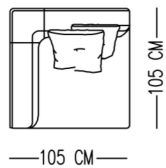

MODULE 06

MODULE 07 (L-R)

MODULE 08 (L-R)

MODULE 09 (L-R)

MODULE 10

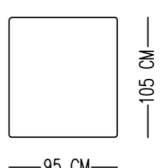
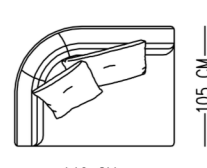
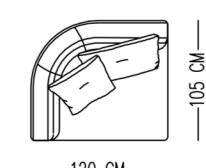
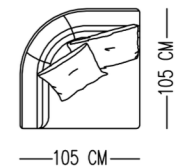
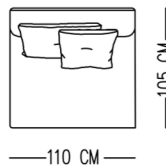

CUSHION 01

CUSHION 02

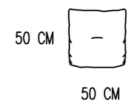
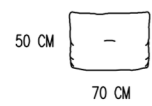

Catalog product-fabric

N-B11/Linen
2103

Catalog product-Legs

Hidden Leg

Alternative fabric
Linen, Boucle and Nubuck



ITALS CORNER SOFA

TECHNICAL SPECIFICATIONS

INTERIOR STRUCTURE BEECH HARDWOOD FRAME AND ELASTIC COLUMN

SEAT CUSHION

HR FOAM

BACK

HR FOAM

UPHOLSTERY TIGHT

MAINTENANCE ALL DECORATIVE CUSHIONS ARE GOOSE DOWN AND SILICON MIX, QUANTITY AND DIMENSIONS ARE AS PER TECHNICAL DRAWINGS. STANDART WITH 3 CUSHIONS 25*55. 1 CUSHIONS 45*45

We recommend shaking and fluffing-up the cushions regularly to maintain the shape. This should be done after removing the cushions from the structure for improved air circulation. For maintenance of fabric and leather, please contact your retailer.

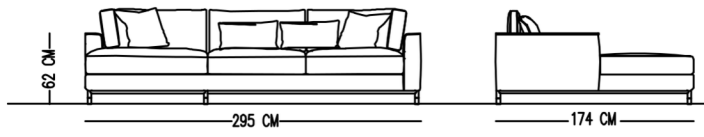

STANDARDS

CORNER SOFA - 295 CM

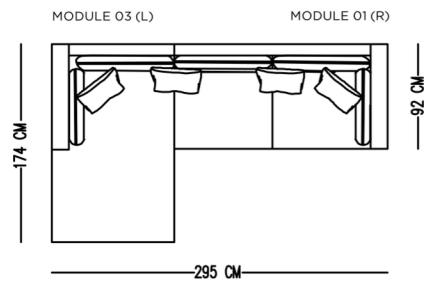

MODULES

MODULE 01 (L-R)

MODULE 02 (L-R)

MODULE 03 (L-R)

MODULE 04 (L-R)

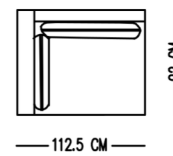
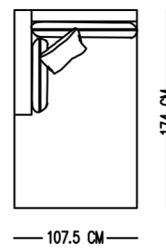
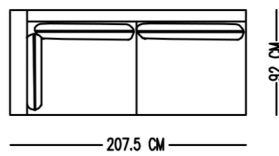
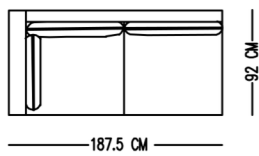

MODULE 05 (L-R)

MODULE 06 (L-R)

CUSHION 01

CUSHION 02

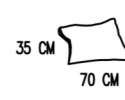
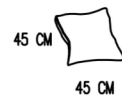
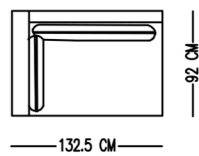
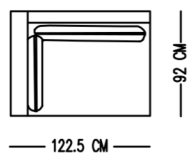

Catalog product-fabric

Catalog product-Legs
Chromium

Etna 3

Alternative fabric
Linen and Boucle



PORTO CORNER SOFA

TECHNICAL SPECIFICATIONS

INTERIOR STRUCTURE BEECH HARDWOOD FRAME AND ELASTIC COLUMN

SEAT CUSHION HR FOAM

BACK HR FOAM

UPHOLSTERY TIGHT

MAINTENANCE ALL DECORATIVE CUSHIONS ARE GOOSE DOWN AND SILICON MIX, QUANTITY AND DIMENSIONS ARE AS PER TECHNICAL DRAWINGS. STANDART WITH 4 CUSHIONS 60*60

We recommend shaking and fluffing-up the cushions regularly to maintain the shape. This should be done after removing the cushions from the structure for improved air circulation. For maintenance of fabric and leather, please contact your retailer.

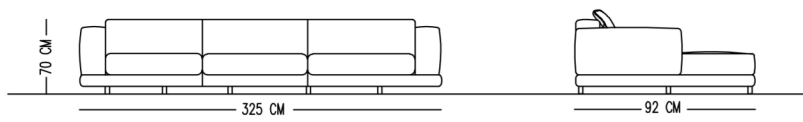

STANDARDS

CORNER SOFA - 325 CM

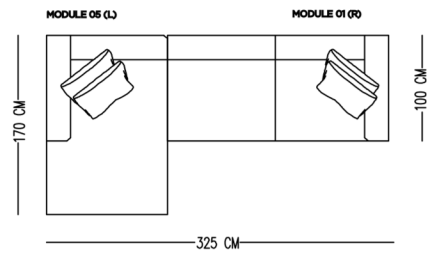

MODULES

MODULE 01 (L-R)

MODULE 02 (L-R)

MODULE 03

MODULE 04 (L-R)

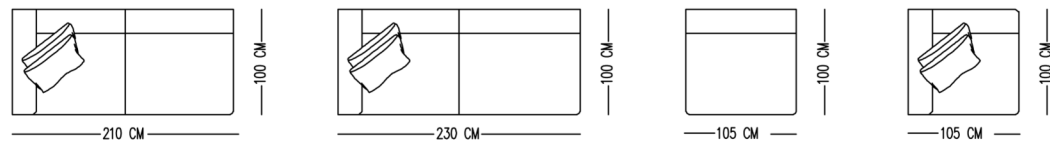

MODULE 05 (L-R)

CUSHION 01

CUSHION 02

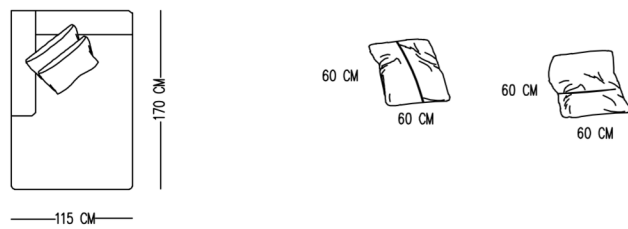

Catalog product-fabric

Catalog product-Legs

Black Painted Metal

N-B39/Linen
2134

Alternative fabric
Linen and Boucle



ANGE CORNER SOFA

TECHNICAL SPECIFICATIONS

INTERIOR STRUCTURE	BEECH WOOD AND ELASTIC COLUMN
SEAT CUSHION	HR FOAM
BACK	HR FOAM
UPHOLSTERY	TIGHT
MAINTENANCE	<p>ALL DECORATIVE CUSHIONS ARE GOOSE DOWN AND SILICON MIX, QUANTITY AND DIMENSIONS ARE AS PER TECHNICAL DRAWINGS. STANDART WITH 3 CUSHIONS 55*55, 3 CUSHIONS 45*45.</p> <p>We recommend shaking and fluffing-up the cushions regularly to maintain the shape. This should be done after removing the cushions from the structure for improved air circulation. For maintenance of fabric and leather, please contact your retailer.</p>

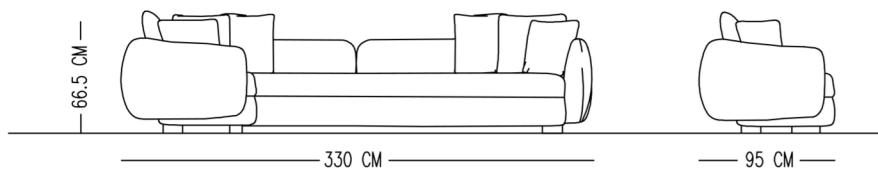

STANDARDS

CORNER SOFA - 330 CM

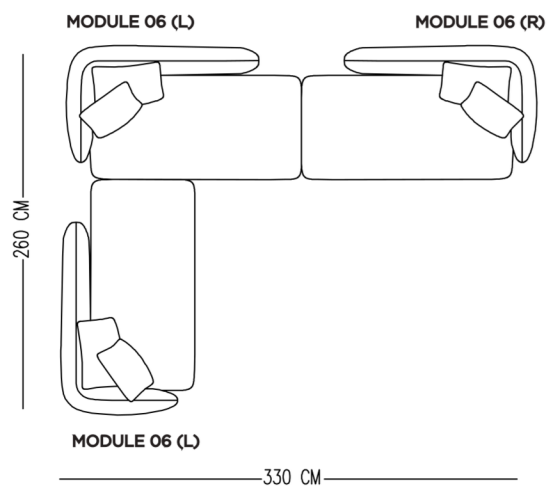

MODULES

MODULE 03 (L-R)

MODULE 04 (L-R)

MODULE 05 (L-R)

MODULE 06 (L-R)

CUSHION 01

CUSHION 02

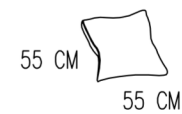
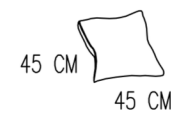
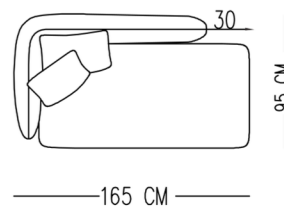
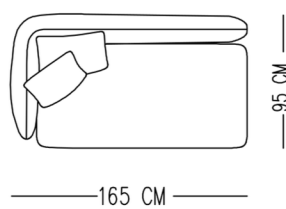
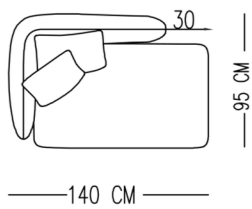
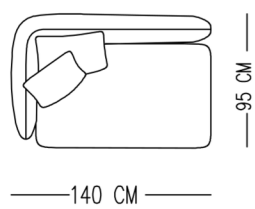

Catalog product-fabric

N-+A11/Boucle
53323

Catalog product-Legs

Black Painted Metal

Alternative fabric
Linen, Linen teddy, Suede and Boucle



PIETRA CORNER SOFA

TECHNICAL SPECIFICATIONS

INTERIOR STRUCTURE FRAME BEECH AND ELASTIC COLUMN

SEAT CUSHION HR FOAM

BACK HR FOAM

UPHOLSTERY TIGHT

MAINTENANCE ALL DECORATIVE CUSHIONS ARE GOOSE DOWN AND SILICON MIX, QUANTITY AND DIMENSIONS ARE AS PER TECHNICAL DRAWINGS. STANDART WITH 4 CUSHIONS 45*45, 3 CUSHIONS 35*50

We recommend shaking and fluffing-up the cushions regularly to maintain the shape. This should be done after removing the cushions from the structure for improved air circulation. For maintenance of fabric and leather, please contact your retailer.

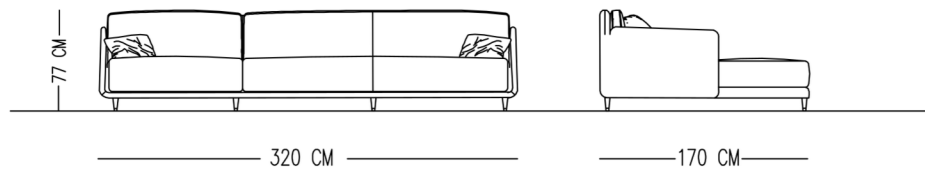

STANDARDS

CORNER SOFA - 320 CM

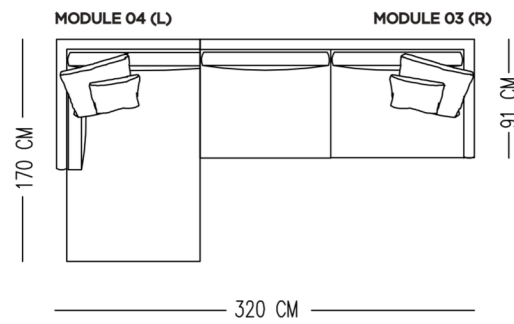

MODULES

MODULE 01 (L-R)

MODULE 02 (L-R)

MODULE 03 (L-R)

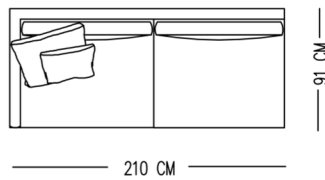
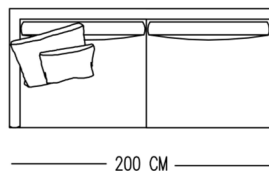
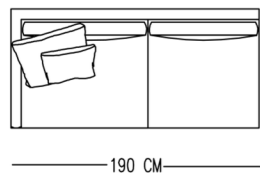

MODULE 04 (L-R)

CUSHION 01

CUSHION 02

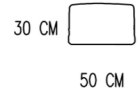
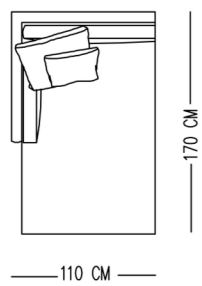

Catalog product-fabric

N-B32/Linen
213-13

Catalog product-Legs

Wood black and brass
old detail

Alternative fabric
Linen and Boucle