

A modern outdoor lounge area. In the center is a green sofa with several cushions and a light-colored throw blanket. To the left is a wooden chair with a woven seat. The background consists of a wall of vertical wooden slats, through which sunlight creates dappled shadows. To the right is a large glass window or door, offering a view of trees and a bright sky. The ceiling is also made of horizontal wooden slats.

OUTDOOR PREMIUM

SitForm.
redefine your space



MOSS GARDEN BED

TECHNICAL SPECIFICATIONS

STRUCTURE	SOLID PANEL
SEAT CUSHION	HR FOAM
BACK	HR FOAM
UPHOLSTERY	TIGHT

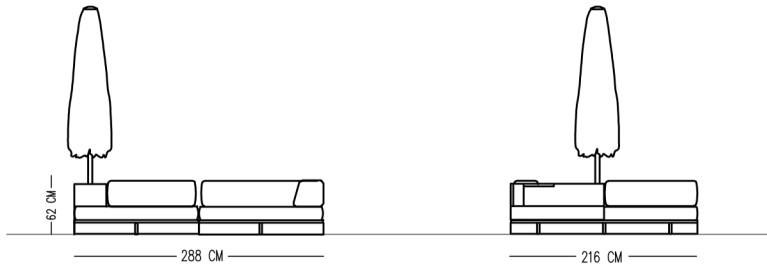

STANDARDS

SUNBED-01

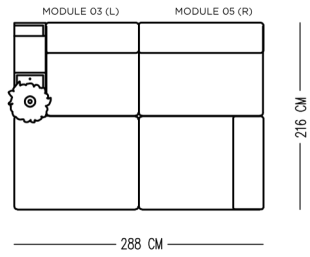

MODULES

MODULE 01

MODULE 02

MODULE 03 (L-R)

MODULE 04 (L-R)

MODULE 05 (L-R)

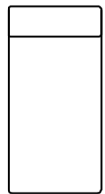

107 CM

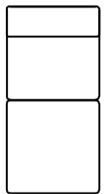

107 CM

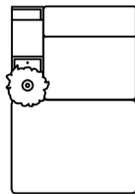

144 CM

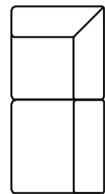

107 CM

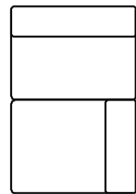

144 CM

MODULE 06



37 CM

Catalog product-fabric
Pedro - 2905

Catalog product-Legs
Iroko Hardwood With Natural Polish



MOSS SUN LOUNGER

TECHNICAL SPECIFICATIONS

STRUCTURE	SOLID PANEL
SEAT CUSHION	HR FOAM
BACK	HR FOAM
UPHOLSTERY	TIGHT

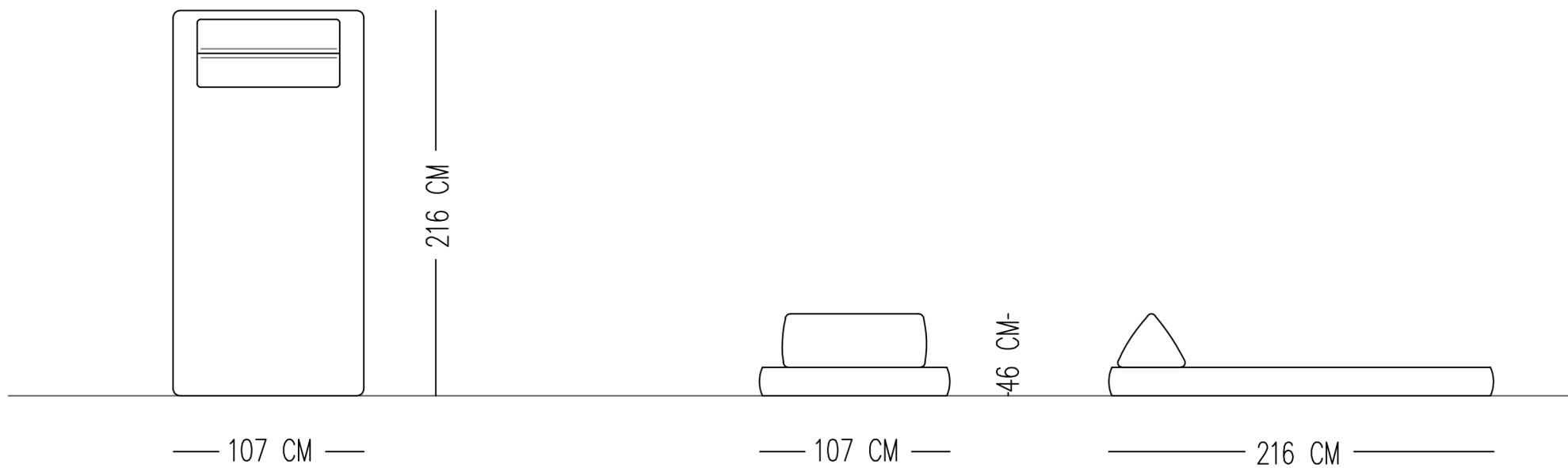

Catalog product-fabric
Pedro - 2905



MOSS COFFEE TABLE

TECHNICAL SPECIFICATIONS

STRUCTURE IROKO WOOD

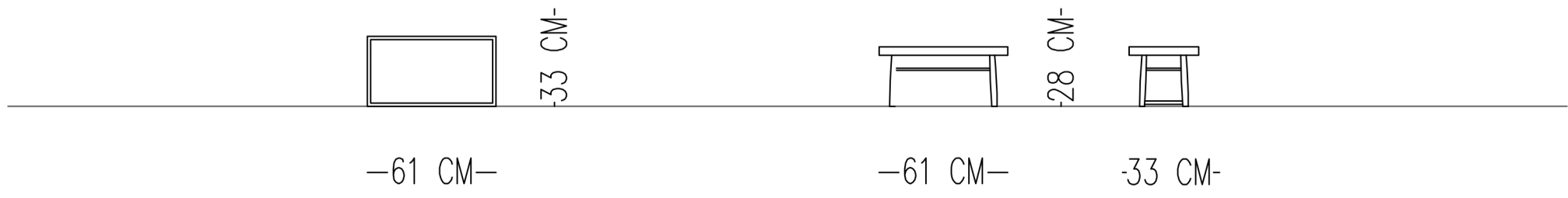

Catalog product
Iroko Hardwood With Natural
Polish



DARI ARMCHAIR

TECHNICAL SPECIFICATIONS

INTERIOR STRUCTURE IROKO

LEGS IROKO

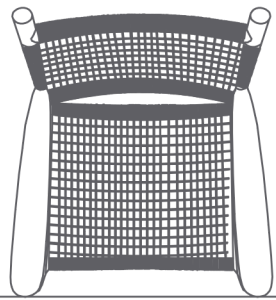
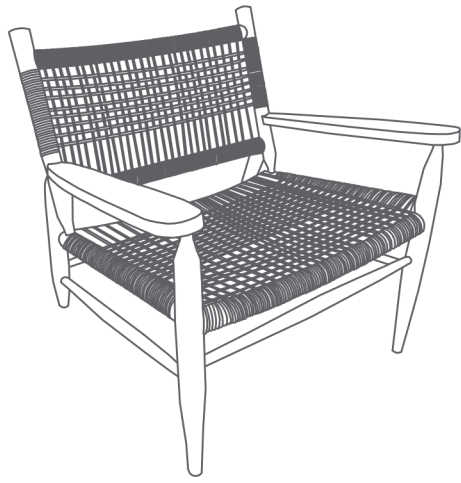

80 CM

—72 CM—

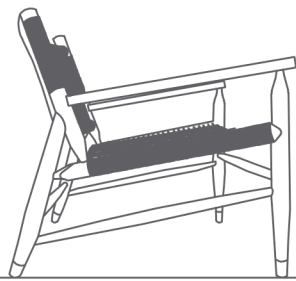

75 CM

—80 CM—

Catalog product-fabric

N-A14/Faux leather rope

Brown Rope

Catalog product-Legs

Ireko

Alternative leg

Oak wood

Alternative fabric

Only N-A14 are available for this model



BENAY OUTDOOR

TECHNICAL SPECIFICATIONS

INTERIOR STRUCTURE PLYWOOD STRUCTURE BEECHWOOD & OUTDOOR PAINTED METAL

SEAT CUSHION HR FOAM

BACK HR FOAM

UPHOLSTERY TIGHT

MAINTENANCE We recommend shaking and fluffing-up the cushions regularly to maintain the shape. This should be done after removing the cushions from the structure for improved air circulation. For maintenance of fabric and leather, please contact your retailer.

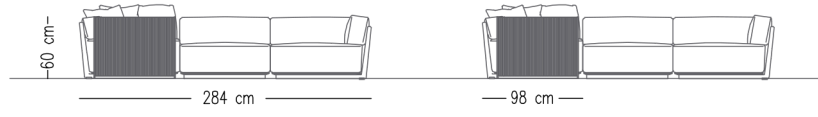
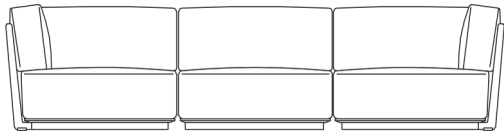

STANDARDS

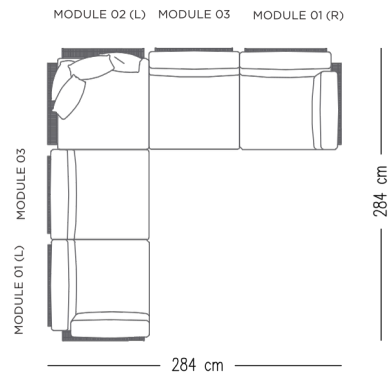
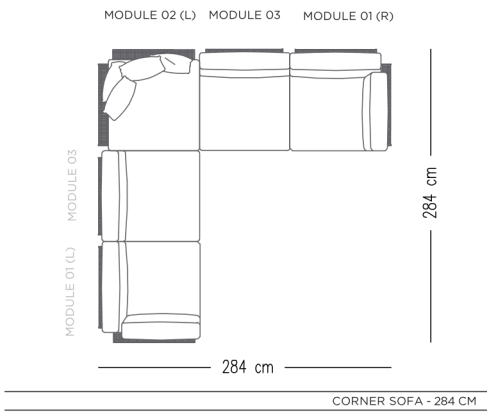

MODULES

MODULE 01 (L-R)

MODULE 02 (L-R)

MODULE 03

MODULE 04 P

CUSHION 01

CUSHION 02

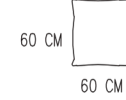
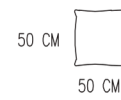
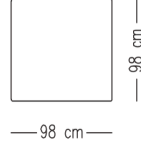
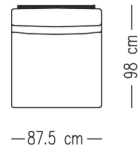
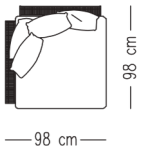
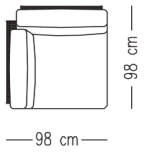

Catalog product

Catalog product-Fabric
N-C16/Linen
337

Catalog product
Aluminium profile



DROP SOFA

TECHNICAL SPECIFICATIONS

INTERIOR STRUCTURE IROKO WOOD & 35 DNS FOAM WITH ZIGZAG BOW

SEAT CUSHION HR FOAM

BACK HR FOAM

UPHOLSTERY TIGHT

MAINTENANCE We recommend shaking and fluffing-up the cushions regularly to maintain the shape. This should be done after removing the cushions from the structure for improved air circulation. For maintenance of fabric and leather, please contact your retailer.

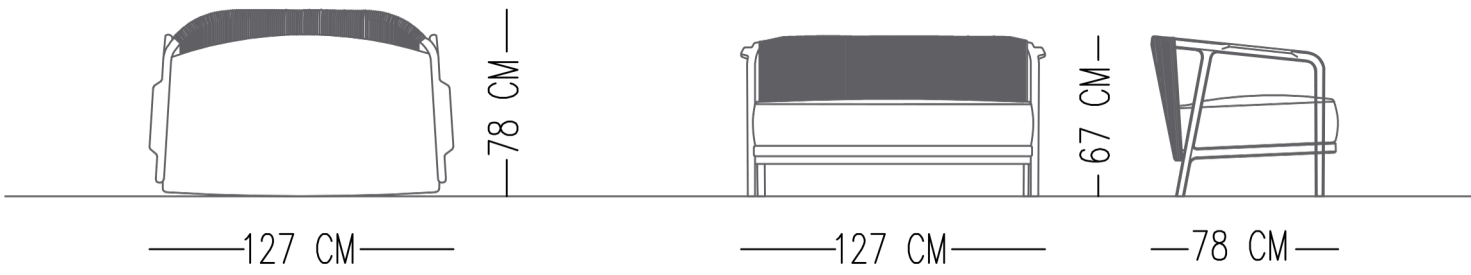
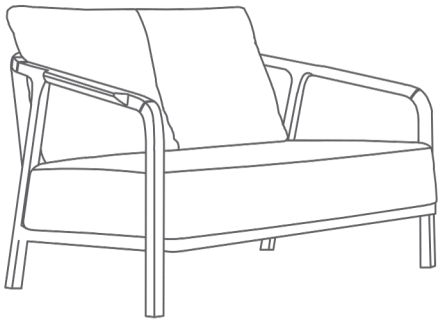

Catalog product

Catalog product-Fabric
N-B40/Linen
aci-01
L

Outdoor
Rope
Light Grey

Catalog product
Iroko hardwood with
natural polish



DROP ARMCHAIR

TECHNICAL SPECIFICATIONS

INTERIOR STRUCTURE	IROKO WOOD & 35 DNS FOAM WITH ZIGZAG BOW MATERIAL VARIATION : WOODEN STRUCTURE IS AVAIBALE IN OAK WOOD OR WALNUT WITH NATURAL POLISH
SEAT CUSHION	HR FOAM
BACK	HR FOAM
UPHOLSTERY	TIGHT
MAINTENANCE	ALL DECORATIVE CUSHIONS ARE %100 GOOSE DOWN, QUANTITY AND DIMENSIONS ARE AS PER TECHNICAL DRAWING We recommend shaking and fluffing-up the cushions regularly to maintain the shape. This should be done after removing the cushions from the structure for improved air circulation. For maintenance of fabric and leather, please contact your retailer.

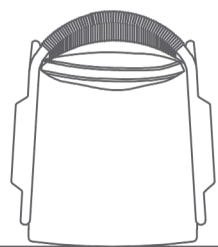
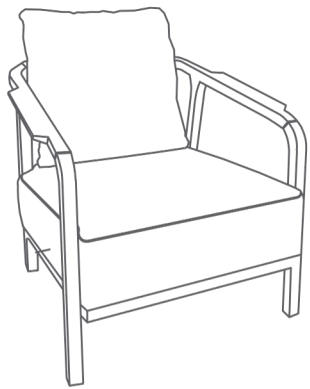

— 70 CM —



81 CM

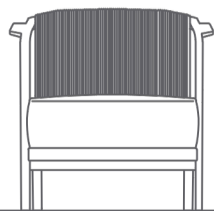

— 70 CM —

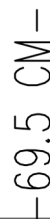

69.5 CM

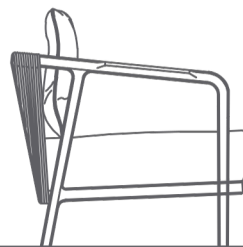

— 81 CM —



82 CM

Catalog product-fabric
N-B40/Linen
Laci-01

Catalog product-Legs
Iroko Hardwood With Natural Polish

Alternative fabric
Linen, Linen teddy, Boucle, Nubuck, Velvet, Faux leather,
Leather and Suede



FAIR SOFA

TECHNICAL SPECIFICATIONS

INTERIOR STRUCTURE BEECHWOOD

SEAT CUSHION HR FOAM

BACK HR FOAM

UPHOLSTERY TIGHT

MAINTENANCE We recommend shaking and fluffing-up the cushions regularly to maintain the shape. This should be done after removing the cushions from the structure for improved air circulation. For maintenance of fabric and leather, please contact your retailer.

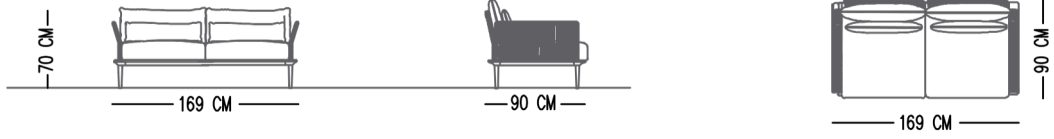
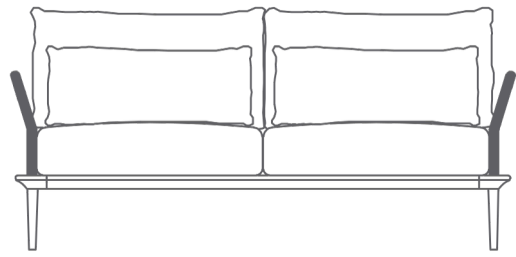

STANDARDS

SOFA - 237.5 CM

SOFA - 169 CM

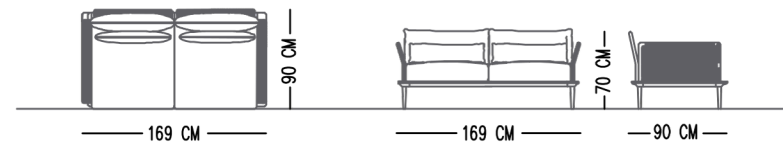
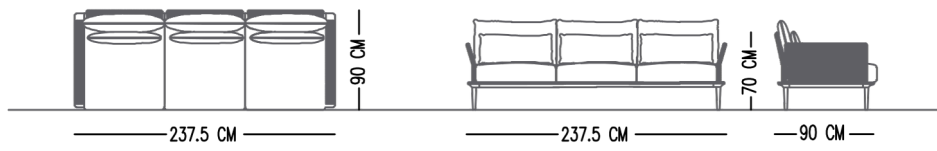

MODULES

CUSHION 01

CUSHION 02

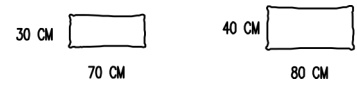

Catalog product

Catalog product-Fabric
N-C16/Linen

168

Leg
Aluminium



FAIR ARMCHAIR

TECHNICAL SPECIFICATIONS

INTERIOR STRUCTURE

BEECHWOOD

SEAT CUSHION

HR FOAM

BACK

HR FOAM

UPHOLSTERY

TIGHT

MAINTENANCE

We recommend shaking and fluffing-up the cushions regularly to maintain the shape. This should be done after removing the cushions from the structure for improved air circulation. For maintenance of fabric and leather, please contact your retailer.

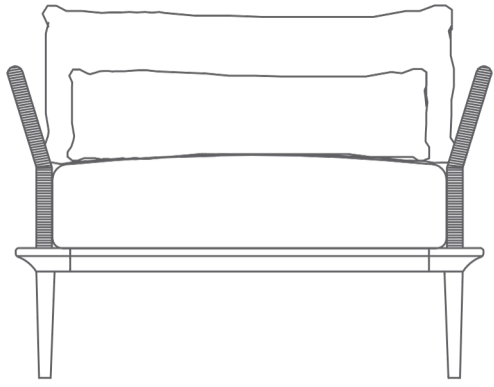

Catalog product

Catalog product-Fabric
N-C16/Linen
524

Leg
Aluminium